

# LJ2205/LJ2206/LJ2206W

Laser Printer

激光打印机

用户手册

User's Guide

! 注意 使用本产品时，请您先仔细阅读使用说明书，再正确操作。

请妥善保管好本手册，以便日后查阅。

!CAUTION Before using this product, read carefully these instructions for correct operation.

Keep the User's Guide in a secure place for future reference.

The Lenovo logo is displayed in white text on a black rectangular background. The background of the entire page features a decorative pattern of grey and white squares arranged in a grid that tapers towards the bottom right.

# To create a better environment

Please cooperate

Firstly, thank you very much indeed for using our Lenovo products!

Lenovo makes a basic policy requires all the workflow from product development to abandonment to care earth environment. The local citizen should be responsible for local society and its environment during these environment protection activities.

Therefore, we hope you'll take part in this environment plan, and pay attention to environment protection points as below while discarding used consumables.

- 1 Please deliver the used package materials to relevant waste disposal office for recycle.
- 2 When you discard used consumables, please follow and carry on relevant local regulations properly.
- 3 When the machine need replacing parts for the maintenance and repair, please discard used circuit boards, used electrical parts and products as disposed electrical materials.
- 4 The power consumption is 0 W after you turn off the machine and unplug it from the AC outlet.
- 5 Some parts in the machine can be used on the same series model machines which produced by the same factory.

Note: If you want to replace the parts, please contact your local authorized repair station.

- 6 Machines with an LwAd > 63.0 dB(A) are recommended to be set up in separate rooms due to their noise emissions.
- 7 The machine can use recycled paper.
- 8 Ensure that during use the machine is used in a well ventilated area.
- 9 Githon will accept machines and consumables for recycling. For details of the return scheme please refer to the webpage <https://www.lenovoimage.com/1.html>
- 10 Githon guarantees to replace the damaged parts during the normal use of the product within five years after discontinued production and provide consumable materials for the product.

# Statement

Welcome to Lenovo products.

Please read carefully all the materials accompanying the machine before installing and using this product for the first time. It will help you make better use of the product. If you fail to operate the product in accordance with the instructions and requirements provided in this manual or mishandle the product due to misunderstanding or other causes, Githon Technology Co., Ltd. shall not be responsible for any losses arising out thereof, except for the loss resulting from improper installation or caused during the process of operation by professional maintenance personnel from our company.

Githon Technology Co., Ltd. has conducted a strict and careful collation of the manual. However, we cannot guarantee that the manual is completely free of any error or omission.

Githon Technology Co., Ltd. is committed to continuously improve product usage and service quality. Accordingly, it reserves the right to make changes to any product or software program described in the manual and information contained herein without prior notice.

The manual is intended to help you use Lenovo products in a correct way, which does not represent any description of software or hardware configuration for the product. In relation to product configuration, please refer to relevant contact (if any) and packing list or consult with the distributor who delivered the product to you. Pictures contained in the manual are for reference only. In case of inconsistency between particular pictures and actual display of the product, please follow the actual display of the product.

Copyright©2022 Githon Technology Co., Ltd. This manual is protected by copyright laws and regulations. Without prior written authorization from Githon Technology Co., Ltd., you shall not reproduce or copy the manual in any way, or transmit the manual via any wireline or wireless network in any form, or translate the manual into any language.

Githon, 至像 and the Stylized 至像 Logo are trademarks or registered trademarks of Githon Technology Co., Ltd. All other trademarks are the property of their respective owners.

©2022 Githon Technology Co., Ltd.



Lenovo, 联想 and the Stylized Lenovo Logo are trademarks or registered trademarks of Lenovo (Beijing) Limited, and are used under license. All other trademarks are the property of their respective owners.

©2022 Lenovo (Beijing) Limited.

If you find any inconsistency between product reality and this manual during the operational process or would like to obtain the latest information or have any problems or suggestions, please log onto:

Website: [www.lenovoimage.com](http://www.lenovoimage.com)

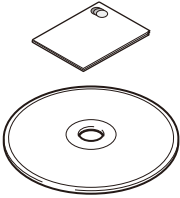
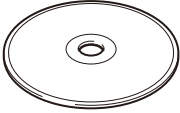
## User's Guides and where to find them?

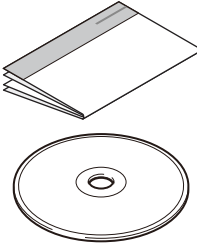
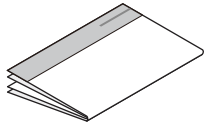
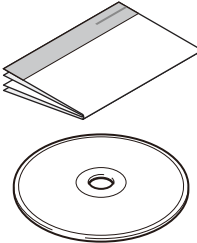
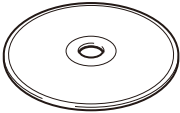
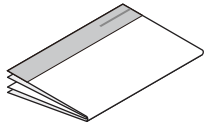
Which manual?	What's in it?	Where is it?	
		Windows® users	Macintosh users
<b>Product Safety Guide</b>	Read this Guide first. Please read the Safety Instructions before you set up your machine. See this Guide for trademarks and legal limitations.	For Chinese:  <a href="http://www.lenovoimage.com">www.lenovoimage.com</a> For English:  <a href="http://www.lenovoimage.com">www.lenovoimage.com</a>	For Chinese:  <a href="http://www.lenovoimage.com">www.lenovoimage.com</a> For English: <a href="http://www.lenovoimage.com">www.lenovoimage.com</a>
<b>Quick Setup Guide</b>	Follow the instructions for setting up your machine and installing the drivers and software for the operating system and connection type you are using.	<b>LJ2205 and LJ2206</b>  <a href="http://www.lenovoimage.com">www.lenovoimage.com</a>	<b>LJ2205 and LJ2206</b>  <a href="http://www.lenovoimage.com">www.lenovoimage.com</a>
		<b>LJ2206W</b> For Chinese:  <a href="http://www.lenovoimage.com">www.lenovoimage.com</a> For English:  <a href="http://www.lenovoimage.com">www.lenovoimage.com</a>	<b>LJ2206W</b> For Chinese:  <a href="http://www.lenovoimage.com">www.lenovoimage.com</a> For English: <a href="http://www.lenovoimage.com">www.lenovoimage.com</a>

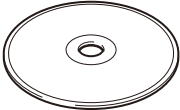
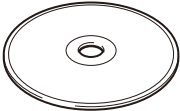
Which manual?	What's in it?	Where is it?	
		Windows® users	Macintosh users
User's Guide	Learn the print operations, how to replace consumables, and performing routine maintenance. See troubleshooting tips.	 <a href="http://www.lenovoimage.com">www.lenovoimage.com</a>	<a href="http://www.lenovoimage.com">www.lenovoimage.com</a>
Network User's Guide LJ2206W	This Guide provides useful information about wireless network settings and security settings using the Lenovo machine. You can also find supported protocol information for your machine and detailed troubleshooting tips.	 <a href="http://www.lenovoimage.com">www.lenovoimage.com</a>	<a href="http://www.lenovoimage.com">www.lenovoimage.com</a>

## Using the documentation

Thank you for buying a Lenovo machine! Reading the documentation will help you make the most of your machine.

### Symbols and conventions used in the documentation

The following symbols and conventions are used throughout the documentation.

 **WARNING**

WARNING indicates a potentially hazardous situation which, if not avoided, could result in death or serious injuries.

**IMPORTANT**  
**NOTE**

IMPORTANT indicates a potentially hazardous situation which, if not avoided, may result in damage to property or loss of product functionality.

Notes tell you how you should respond to a situation that may arise or give tips about how the operation works with other features.

Prohibition icons indicate actions that must not be performed.



Electrical Hazard icons alert you to possible electrical shock.



Fire Hazard icons alert you to the possibility of fire.



Hot Surface icons warn you not to touch machine parts that are hot.

**Bold**  
*Italics*

**Bold style** identifies keys on the machine control panel or computer screen.  
*Italicized style* emphasizes an important point or refers you to a related topic.

# Accessing Lenovo Utilities (Windows®)

**Lenovo Utilities**  is an application launcher that offers convenient access to all Lenovo applications installed on your device.

- 1 (Windows® XP, Windows Vista®, Windows® 7, Windows Server® 2003, Windows Server® 2008 and Windows Server® 2008 R2)

Click  (**Start**) > **All Programs** > **Lenovo** > Lenovo Utilities.

(Windows® 8 and Windows Server® 2012)

Tap or double-click  (Lenovo Utilities) either on the **Start** screen or the desktop.

(Windows® 8.1 and Windows Server® 2012 R2)

Move your mouse to the lower left corner of the **Start** screen and click  (if you are using a touchbased device, swipe up from the bottom of the **Start** screen to display the **Apps** screen).

When the **Apps** screen appears, tap or click  (**Lenovo Utilities**).

- 2 Select your machine.

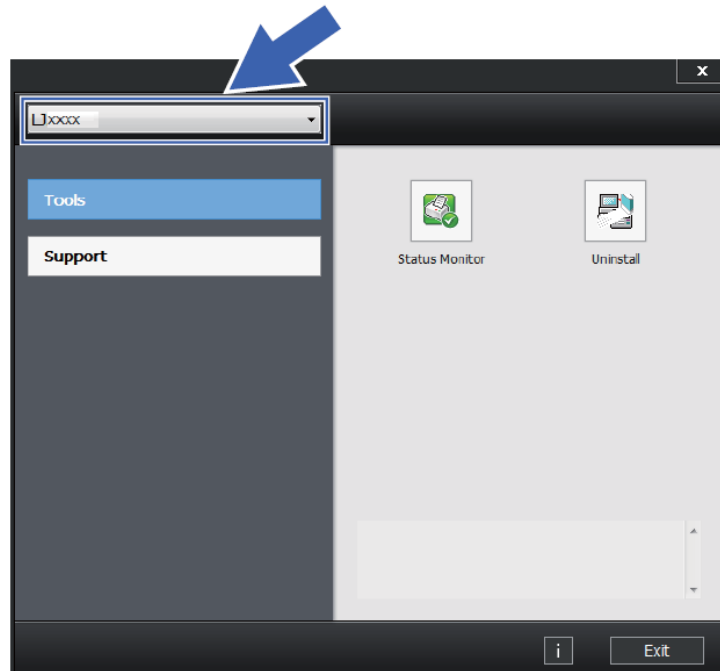

- 3 Choose the operation you want to use.

# Table of Contents

<b>1</b>	<b>Printing Methods</b>	<b>1</b>
	About this Machine .....	1
	Machine overview .....	1
	Acceptable paper .....	2
	Recommended Paper .....	2
	Paper capacity of the paper tray .....	2
	2-sided printing .....	3
	Guidelines for printing on both sides of the paper .....	3
	Manual 2-sided printing .....	4
<b>2</b>	<b>Driver and Software</b>	<b>5</b>
	Printer driver .....	5
	Printing a document .....	6
	Printer driver settings .....	7
	Windows® .....	8
	Accessing the printer driver settings .....	8
	Features in the Windows® printer driver .....	8
	Basic tab .....	9
	Advanced tab .....	14
	Print Profiles tab .....	20
	Device Settings tab .....	22
	Uninstalling the printer driver .....	23
	Status Monitor .....	24
	Macintosh .....	26
	Features in the printer driver (Macintosh) .....	26
	Choosing page setup options .....	26
	Removing the printer driver .....	32
	Status Monitor .....	33
	Software for networks (LJ2206W only) .....	34
<b>3</b>	<b>General Information</b>	<b>35</b>
	Control panel .....	35
	LEDs (Light Emitting Diodes) .....	35
	Service call indications .....	39
	Power On/Off key .....	40
	Print a Printer Settings page .....	41
	Using the Power On/Off key .....	41
	Using the printer driver .....	41
	Ecology features .....	42
	Toner Save .....	42
	Sleep Time .....	42
	Deep Sleep mode .....	42
	Auto Power Off .....	42

<b>A</b>	<b>Troubleshooting and other information</b>	<b>43</b>
	Consumable items .....	43
	Toner Setting .....	44
	Identifying your problem .....	45
	Error messages in the Status Monitor .....	46
	Improving the print quality.....	47
	Paper jams.....	51
	If you are having difficulty with your machine .....	55
	Cleaning and Checking the machine .....	57
	Machine Information .....	58
	Default settings.....	58
<b>B</b>	<b>Specifications</b>	<b>60</b>
	General .....	60
	Print media.....	62
	Important information for choosing your paper .....	63
	Printer .....	64
	Network (LAN) (LJ2206W only).....	65
<b>C</b>	<b>Index</b>	<b>66</b>



## About this Machine

### Machine overview

---

LJ2205 and LJ2206

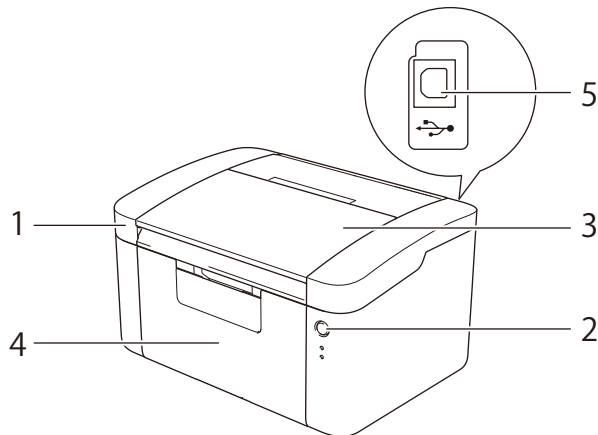

LJ2206W

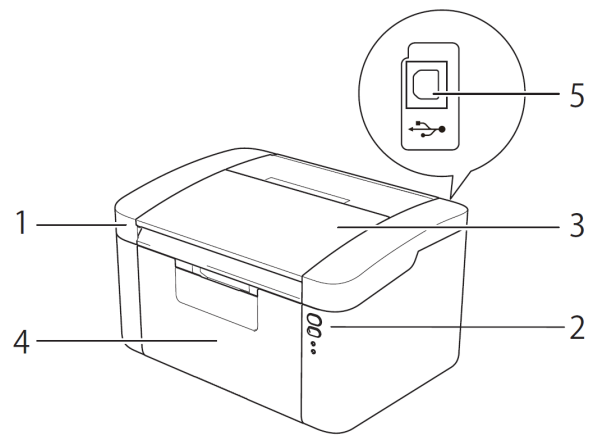

- 1 Top cover
- 2 Control panel
- 3 Face-down output tray support flap (support flap)
- 4 Paper tray
- 5 USB port

### NOTE

For details about how the LEDs show the machine's status, see *LEDs (Light Emitting Diodes)* on page 35.  
For the Power On/Off key functions, see *Power On/Off key* on page 40.

---

## Acceptable paper

Print quality may vary according to the type of paper you are using.

For best results, follow the instructions below:

- DO NOT put different types of paper in the paper tray at the same time because it may cause paper jams or misfeeds.
- For correct printing, you must choose the same paper size from your software application as the paper in the tray.
- Avoid touching the printed surface of the paper immediately after printing.
- Before you buy a lot of paper, test a small quantity to make sure that the paper is suitable.

## Recommended Paper

Plain paper	APP Blue Flag Ship 70g/m <sup>2</sup> APP Gold Flag Ship 80g/m <sup>2</sup> Advanced Agro Double A 80g/m <sup>2</sup>
-------------	---

## Paper capacity of the paper tray

Paper size	Paper type	No. of sheets	Paper weight
A4, Letter, Legal, Folio <sup>1</sup> , A5, A5(Long Edge), B5, Executive, 16K(195x270mm), 16K(184x260mm), 16K(197x273mm)	Plain paper and Recycled paper	up to 150 sheets (80 g/m <sup>2</sup> )	65 - 105 g/m <sup>2</sup>

<sup>1</sup> Folio size is 215.9 mm x 330.2 mm.

## 2-sided printing

The supplied printer drivers all enable 2-sided printing. For more information about how to choose the settings, see *2-sided / Booklet* on page 11 for Windows® and see *2-sided Printing* on page 32 for Macintosh.

### Guidelines for printing on both sides of the paper

---

- If the paper is thin, it may wrinkle.
- If paper is curled, straighten it and put it back in the paper tray. If the paper continues to curl, replace the paper.
- If the paper is not feeding correctly, it may be curled. Remove the paper and straighten it. If the paper continues to curl, replace the paper.
- When you use the manual 2-sided function, it is possible that there may be paper jams or poor print quality. (If there is a paper jam, see *Paper jams* on page 51. If you have a print quality problem, see *Improving the print quality* on page 47.)

## Manual 2-sided printing

---

If you are using the Macintosh Printer Driver, see *Manual 2-sided Printing* on page 32.

1

### Manual 2-sided printing with the Windows® printer driver

- 1 Choose the following settings from each drop-down list of the printer driver.
  - **Paper Size**  
You can use all the paper sizes specified for the tray you are using.
  - **Media Type**  
You can use all the media types that are specified for the tray you are using.
  - **2-sided / Booklet**  
Choose **2-sided (Manual)**.
  - **2-sided Type** in **2-sided Settings**  
There are four options for each orientation. (See *2-sided / Booklet* on page 11.)
  - **Binding Offset** in **2-sided Settings**  
You can specify the offset for binding. (See *2-sided / Booklet* on page 11.)

For any other settings, see *Driver and Software* in Chapter 2.

- 2 Send the print data to the machine. The machine will print all the even-numbered pages on one side of the paper first. Then, the Windows® driver instructs you (with a pop-up message) to reinsert the paper to print the odd-numbered pages.

### NOTE

---

Before reinserting the paper, straighten it well, or you may get a paper jam. Very thin or thick paper is not recommended.

---

## Printer driver

A printer driver is software that translates data from the format used by a computer to the format that a particular printer needs. Typically, this format is page description language (PDL).

The printer drivers for the supported versions of Windows<sup>®</sup> is on the CD-ROM we have supplied and for Macintosh it is on the Githon Support Website at [www.lenovoimage.com](http://www.lenovoimage.com). Install the drivers by following the steps in the Quick Setup Guide. The latest printer drivers for Windows<sup>®</sup> and Macintosh can be downloaded from the Githon Support Website at:

[www.lenovoimage.com](http://www.lenovoimage.com)

### For Windows<sup>®</sup>

- Windows<sup>®</sup> printer driver (the most suitable printer driver for this product)

### For Macintosh

- Macintosh printer driver (the most suitable printer driver for this product)

### For Linux<sup>®</sup> 1 2

- LPR printer driver
- CUPS printer driver

<sup>1</sup> For more information and to download the printer driver for Linux please visit your model page at [www.lenovoimage.com](http://www.lenovoimage.com) or use the link on the CD-ROM we have supplied.

<sup>2</sup> Depending on Linux distributions, the driver may not be available or it may be released after the initial release of your model.

## Printing a document

---

When the machine receives data from your computer, it begins printing by picking up paper from the paper tray. The paper tray can feed plain paper and recycled paper to the machine. (See *Paper capacity of the paper tray* on page 2.)

- 1 From your application, choose the Print command.  
If any other printer drivers are installed on your computer, choose **Lenovo LJXXXX** (where XXXX is your model name) as your printer driver from the Print or Print Settings menu in your software application, and then click **OK** or **Print** to begin printing.
- 2 Your computer sends the data to the machine. The **Ready** LED (○) will blink.
- 3 When the machine finishes printing all the data, the **Ready** LED (○) finishes blinking.

### NOTE

---

- You can choose the paper size and orientation in your application software.
  - If your application software does not support your custom paper size, choose the next largest paper size.
  - Then adjust the print area by changing the right and left margins in your application software.
-

## Printer driver settings

---

You can change the following printer settings when you print from your computer:

- Paper Size
- Orientation
- Copies
- Media Type
- Print Quality (For LJ2205 and LJ2206)  
Resolution (For LJ2206W)
- Print Settings
- Multiple Page
- 2-sided / Booklet
- Print Preview
- Scaling
- Reverse Print
- Use Watermark
- Header-Footer Print
- Toner Save Mode
- Administrator
- Density Adjustment
- Improve Print Output
- Skip Blank Page
- Print Text in Black
- Print Archive
- Print Profile

# Windows<sup>®</sup>

## Accessing the printer driver settings

---

- 1 (For Windows<sup>®</sup> XP and Windows Server<sup>®</sup> 2003)

Click **Start**, and then **Printers and Faxes**.

(For Windows Vista<sup>®</sup> and Windows Server<sup>®</sup> 2008)

Click the  (**Start**) button, **Control Panel**, **Hardware and Sound**, and then **Printers**.

(For Windows<sup>®</sup> 7 and Windows Server<sup>®</sup> 2008 R2)

Click the  (**Start**) button, and then click **Devices and Printers**.

(For Windows<sup>®</sup> 8)

Move your mouse to the lower right corner of your desktop. When the menu bar appears, click **Settings**, and then click **Control Panel**. In the **Hardware and Sound** group, click **View devices and printers**.

(For Windows Server<sup>®</sup> 2012 and Windows Server<sup>®</sup> 2012 R2)

Move your mouse to the lower right corner of your desktop. When the menu bar appears, click **Settings**, and then click **Control Panel**. In the **Hardware** group, click **View devices and printers**.

- 2 Right-click the **Lenovo LJXXXX** icon (where XXXX is your model name) and select **Printer properties (Properties)**, and **Lenovo LJXXXX** if necessary. The printer properties dialog box appears.
- 3 Choose the **General** tab and then click **Preferences... (Printing Preferences...)**.

## Features in the Windows<sup>®</sup> printer driver

---

For more information, see the **Help** text in the printer driver.

### NOTE

---

- The screens in this section are from Windows<sup>®</sup> 7. The screens on your PC will vary depending on your operating system.
  - To access the printer driver settings, see *Accessing the printer driver settings* on page 8.
-



## Basic tab

You can also change the Page Layout settings by clicking the illustration on the left side of the **Basic** tab.

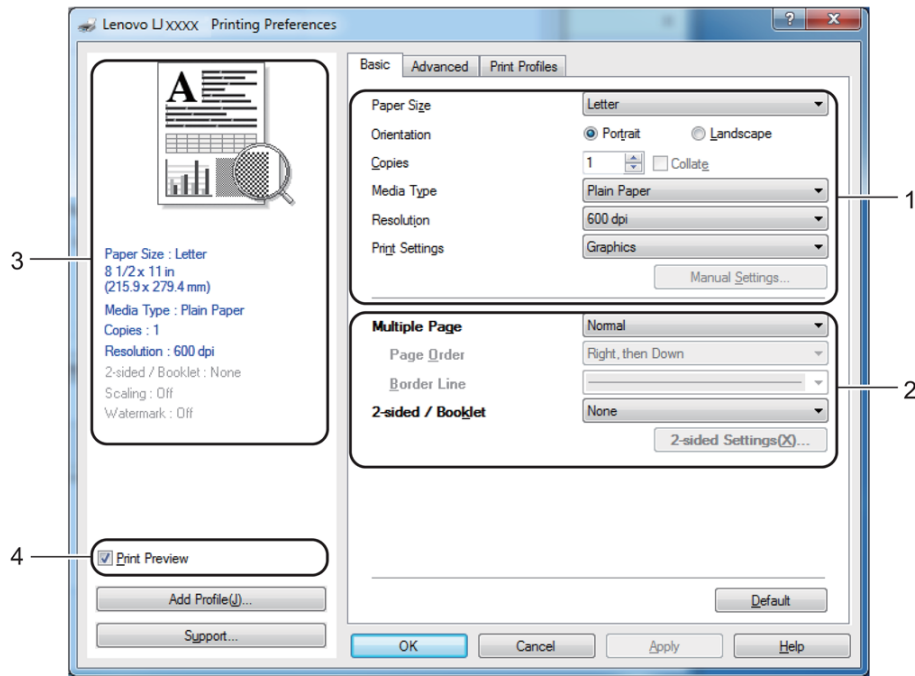

- 1 Choose the **Paper Size**, **Orientation**, **Copies**, **Media Type**, **Print Quality**<sup>1</sup> or **Resolution**<sup>2</sup> and **Print Settings** (1).
- 2 Choose **Multiple Page** and **2-sided / Booklet** (2).
- 3 Confirm your current settings in the window (3).
- 4 Click **OK** to apply your chosen settings.  
To return to the default settings, click **Default**, then **OK**.

<sup>1</sup> For LJ2205 and LJ2206

<sup>2</sup> For LJ2206W

## NOTE

If you want to preview your document before printing, check the Print Preview check box (4).

## Paper Size

From the drop-down list choose the Paper Size you are using.

## Orientation

Orientation selects the position of how your document will be printed (**Portrait** or **Landscape**).

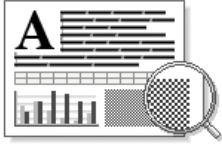
Portrait (Vertical)	Landscape (Horizontal)
	

## Copies

The copies selection sets the number of copies that will be printed.

### ■ Collate

With the Collate check box selected, one complete copy of your document will be printed and then repeated for the number of copies you selected. If the Collate check box is not selected, then each page will be printed for all the copies selected before the next page of the document is printed.

Collate checked

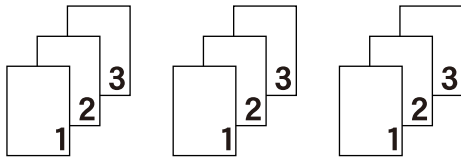

Collate non-checked

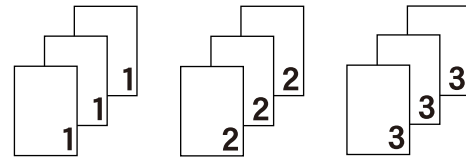

## Media Type

You can use the following types of media in your machine. For the best print quality, select the type of media that you wish to use.

- Plain Paper
- Recycled Paper

## Print Quality (For LJ2205 and LJ2206)

You can choose the print quality as follows.

- Draft
- Normal
- Fine

## Resolution (For LJ2206W)

You can change the resolution as follows:

- 300 dpi
- 600 dpi
- HQ 1200

## Print Settings

You can change the print settings as follows:

### ■ Graphics

This is the best mode for printing documents that contain graphics.

### ■ Text

This is the best mode for printing text documents.

### ■ Manual

You can change the settings manually by choosing **Manual** and clicking the **Manual Settings...** button. You can set brightness, contrast and other settings.

## Multiple Page

The Multiple Page selection can reduce the image size of a page allowing multiple pages to be printed on one sheet of paper or enlarge the image size for printing one page on multiple sheets of paper.

### ■ Page Order

When **N in 1** option is selected, the page order can be selected from the drop-down list.

### ■ Border Line

When printing multiple pages onto one sheet, with the Multiple Page feature, you can choose to have a solid border, dash border or no border around each page on the sheet.

### ■ Print cut-out line

When **1 in NxN Pages** option is selected, the **Print cut-out line** option can be selected. This option allows you to print a faint cut-out line around the printable area.

## 2-sided / Booklet

When you want to print a booklet or do 2-sided printing, use this function.

### ■ None

This disables 2-sided printing.

### ■ 2-sided (Manual)

When you want to do 2-sided printing, use this option.

#### • 2-sided (Manual)

The machine prints all the even numbered pages first. Then the printer driver will stop and show the instructions required to re-insert the paper. When you click **OK** the odd numbered pages will be printed.

When you choose **2-sided (Manual)**, the **2-sided Settings...** button becomes available to choose. You can set following settings in the **2-sided Settings** dialog box.

#### • 2-sided Type

There are four types of 2-sided binding directions available for each orientation.

**Portrait**

**Long Edge (Left)**

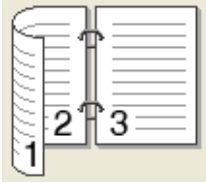

**Long Edge (Right)**

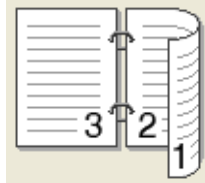

**Short Edge (Top)**

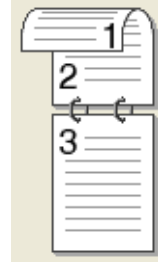

**Short Edge (Bottom)**

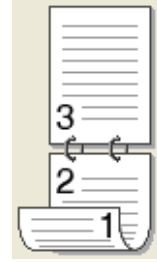

**Landscape**

**Long Edge (Top)**



**Long Edge (Bottom)**

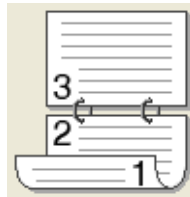

**Short Edge (Right)**

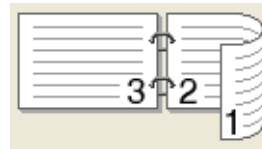

**Short Edge (Left)**

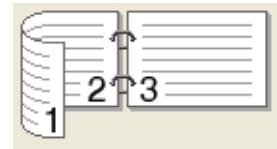

• **Binding Offset**

When you check **Binding Offset**, you can also specify the offset for binding in inches or millimetres.

■ **Booklet (Manual)**

Use this option to print a document in booklet format using 2-sided printing; it will arrange the document according to the correct page number and allows you to fold at the centre of the print output without having to change the order of the page number.

When you choose **Booklet (Manual)**, the **2-sided Settings...** button becomes available to choose. You can set the following settings in the **2-sided Settings** dialog box.

• **2-sided Type**

There are two types of 2-sided binding directions available for each orientation.

**Portrait**

**Left Binding**

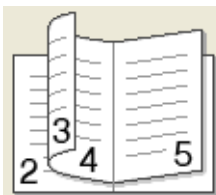

**Right Binding**

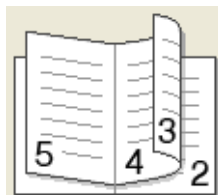

**Landscape**

**Top Binding**



**Bottom Binding**

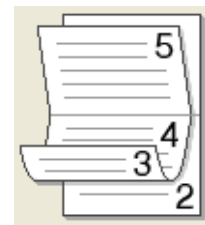

- **Booklet Printing Method**

When **Divide into Sets** is selected:

This option allows you to print the whole booklet into smaller individual booklet sets, it still allows you to fold at the center of the smaller individual booklet sets without having to change the order of the page number. You can specify the number of sheets in each smaller booklet set, from 1 to 15. This option can help when folding the printed booklet that has a large number of pages.

- **Binding Offset**

When you check **Binding Offset**, you can also specify the offset for binding in inches or millimetres.

## Print Preview

You can preview a document before it is printed. If you check the **Print Preview** check box, the Print Preview Viewer window will open before printing starts.

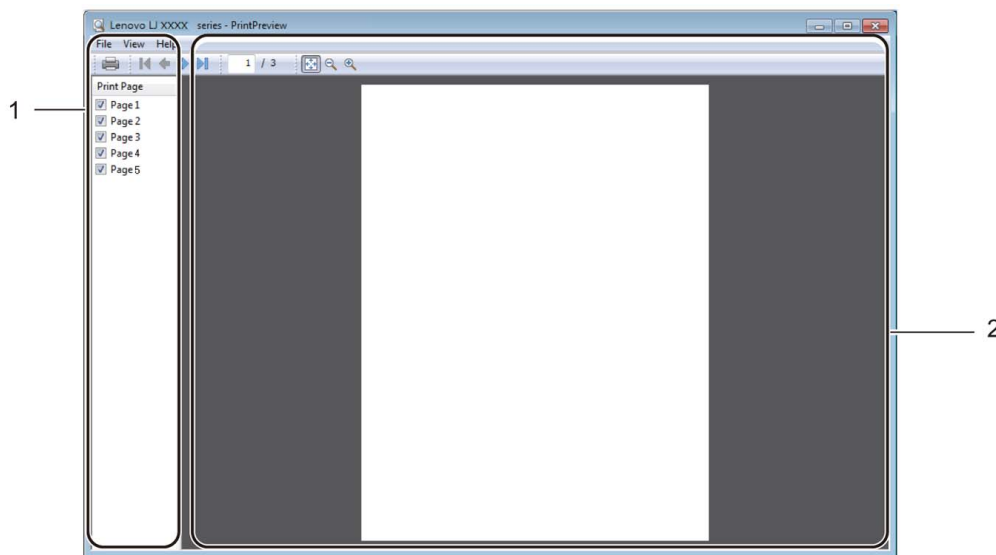

### 1 Page List Area

The Page List Area displays the page numbers for the actual pages that will be printed. If you chose a page in this list, a preview of the print results for the page will be displayed in the Preview Area.

If you do not want to print a page, clear the check mark.

### 2 Preview Area

The Preview Area displays a preview of the print results for the pages chosen in the Page List Area.

## NOTE

If **2-sided (Manual)** or **Booklet (Manual)** was chosen in the Printer driver settings, you cannot use the Print Preview function.

## Advanced tab

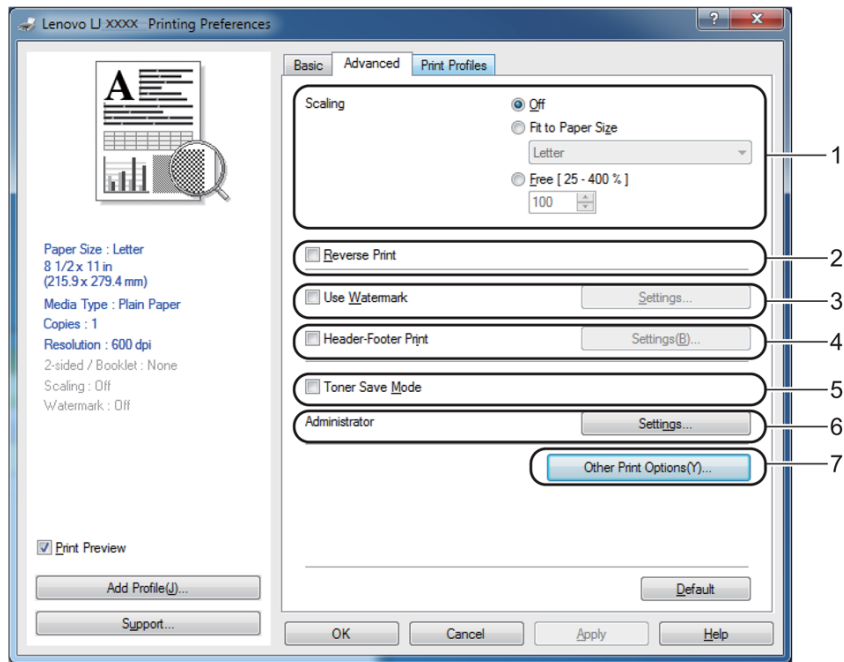

Change the tab settings by clicking one of the following selections:

- **Scaling** (1)
- **Reverse Print** (2)
- **Use Watermark** (3)
- **Header-Footer Print** (4)
- **Toner Save Mode** (5)
- **Administrator** (6)
- **Other Print Options** (7)

### Scaling

You can change the print image scaling.

### Reverse Print

Check **Reverse Print** to reverse the document 180 degrees.

### Use Watermark

You can put a logo or text into your document as a watermark. You can choose one of the preset Watermarks, or you can use a bitmap file that you have created. Check **Use Watermark** and then click the **Settings...** button.

## Watermark Settings

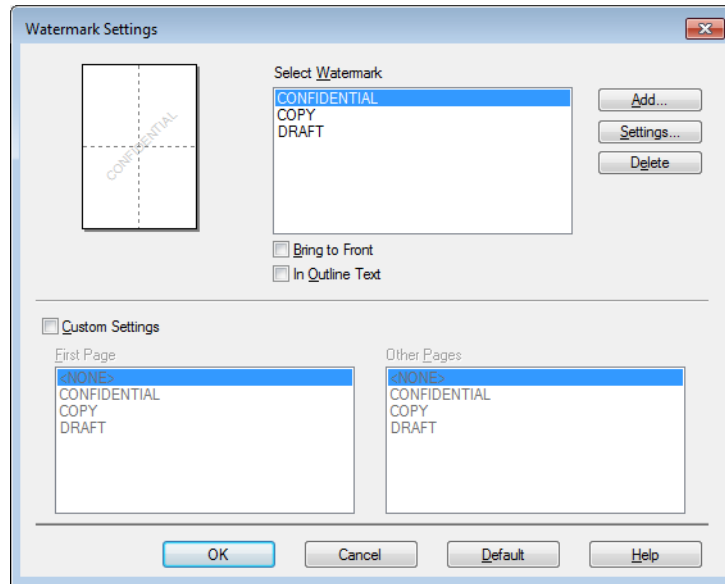

### ■ Select Watermark

Choose a watermark to use.

To make an original watermark, click the **Add** button to add the watermark settings and then choose **Use Text** or **Use Image** in **Watermark Style**.

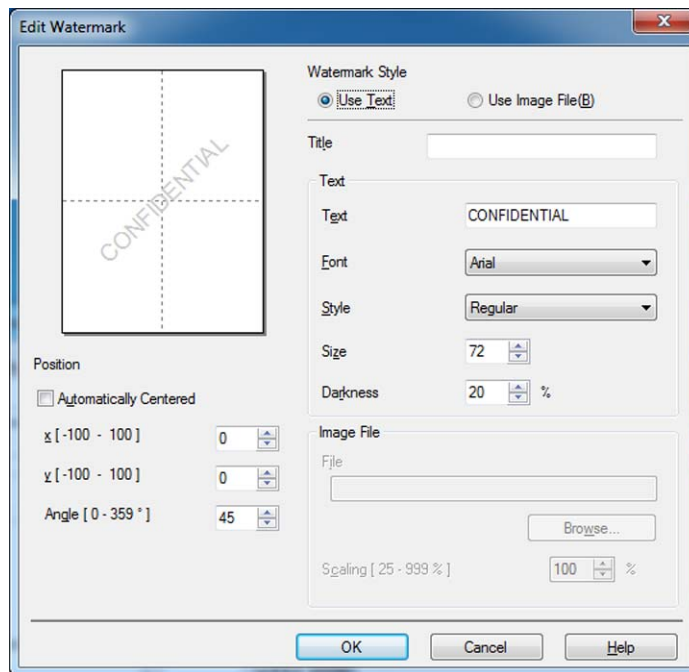

- **Title**

Enter a suitable title into the field.

- **Text**

Enter your Watermark Text into the **Text** box, and then choose the **Font, Style, Size** and **Darkness**.

- **Image File**

Enter the file name and location of your bitmap image in the **File** box, or click **Browse** to search for the file. You can also set the scaling size of the image.

- **Position**

Use this setting if you want to control the position of the watermark on the page.

- **Bring to Front**

This option will overlay the selected characters or image onto your printed document.

- **In Outline Text**

Check **In Outline Text** if you only want to print an outline of the watermark. It is available when you choose a text watermark.

- **Custom Settings**

You can choose which watermark is to be printed on the first page or on the other pages.

## Header-Footer Print

When this feature is enabled, it will print the date and time on your document from your computer's system clock and the PC login user name or the text you entered. Check **Header-Footer Print**, and then click the **Settings...** button.

- **ID Print**

If you select **Login User Name**, your PC login user name will be printed. If you select **Custom** and enter the text in the **Custom** edit box, the text you entered will be printed.

## Toner Save Mode

You can conserve toner use with this feature. When you set **Toner Save Mode** to on, print appears lighter. The default setting is off.

### NOTE

---

- We do not recommend **Toner Save Mode** for printing photo or Greyscale images.
  - **Toner Save Mode** is not available for **Fine** for Print Quality <sup>1</sup> or **HQ 1200** for Resolution <sup>2</sup> is selected.
- 

<sup>1</sup> For LJ2205 and LJ2206

<sup>2</sup> For LJ2206W



## Administrator

Administrators have the authority to limit access to functions such as scaling and watermark.

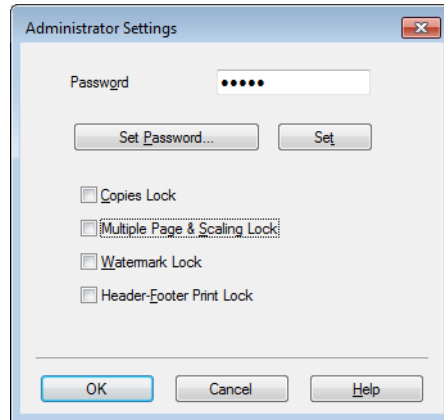

### ■ Password

Enter the password into this box.

## NOTE

Click **Set Password...** to change the password.

### ■ Copies Lock

Lock the copy pages selection to prevent multiple copy printing.

### ■ Multiple Page & Scaling Lock

Lock the scaling setting and multiple page setting.

### ■ Watermark Lock

Lock the current settings of the Watermark option to prevent changes being made.

### ■ Header-Footer Print Lock

Lock the current settings of the Header-Footer Print option to prevent changes being made.

## Other Print Options

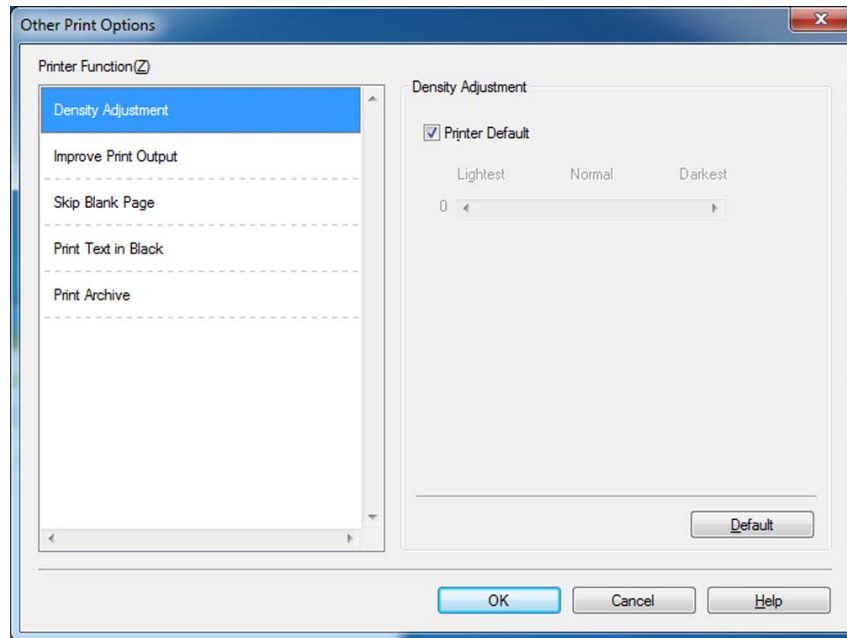

You can set the following in Printer Function:

- **Density Adjustment**
- **Improve Print Output**
- **Skip Blank Page**
- **Print Text in Black**
- **Print Archive**

### Density Adjustment

Increase or decrease the print density.

#### NOTE

**Density Adjustment** is not available when **Fine** is selected for **Print Quality** (LJ2205/LJ2206) or **HQ1200** is selected for **Resolution** (LJ2206W).

### Improve Print Output

This feature allows you to improve a print quality problem.

#### ■ Reduce Paper Curl

If you choose this setting, the paper curl may be reduced.

If you are printing only a few pages, you do not need to choose this setting.

#### NOTE

This operation will decrease the temperature of the machine's fusing process.

### ■ Improve Toner Fixing

If you choose this setting, the toner fixing capabilities may be improved.

#### NOTE

This operation will increase the temperature of the machine's fusing process.

### Skip Blank Page

If **Skip Blank Page** is checked, the printer driver automatically detects blank pages and excludes them from printing.

#### NOTE

This option does not work when you choose the following options:

- **Use Watermark**
- **Header-Footer Print**
- **N in 1** or **1 in NxN Pages** in **Multiple Page**
- **2-sided (Manual), Booklet (Manual)** in **2-sided / Booklet**
- **Print Preview**

### Print Text in Black

This function enables printing all text in Black only.

#### NOTE

It may not work with certain characters.

### Print Archive

A copy of your printout can be saved as a PDF file to your computer. To change the file size, move the **File Size** slider to the right or left. The resolution is set according to the file size.

#### NOTE

By enabling this feature, there may be a longer wait before your machine begins printing.

This option does not work when you choose the following options:

- **Use Watermark**
- **Header-Footer Print**
- **N in 1** or **1 in NxN Pages** in **Multiple Page**
- **2-sided (Manual), Booklet (Manual)** in **2-sided / Booklet**
- **Print Preview**

## Print Profiles tab

**Print Profiles** are editable presets designed to give you quick access to frequently used printing configurations.

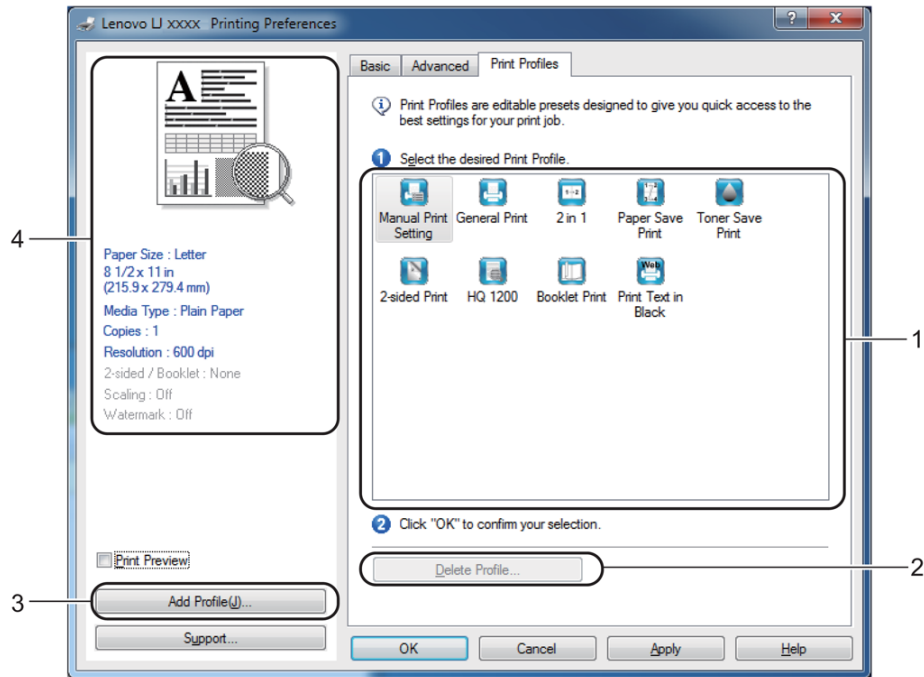

- **Print profile box (1)**
- **Delete Profile (2)**
- **Add Profile (3)**
- **Current print profile view (4)**

- 1 Choose your profile from the print profile box.
- 2 Click **OK** to apply your chosen profile.

### Add Profile

The **Add Profile** dialog box appears by clicking **Add Profile**. You can add 20 new profiles with your preferred settings.

- 1 Enter the desired title in **Name**.
- 2 Choose an icon you want to use from the Icon list, then click **OK**.
- 3 The current settings shown on the left side of the printer driver window will be saved.

## Delete Profile

The **Delete Profile** dialog box appears by clicking **Delete Profile**. You can delete any of the profiles you have added.

- 1 Choose your profile from the print profile box.
- 2 Click **Delete**.
- 3 Click **Yes**.
- 4 The selected profile will be deleted.

## Device Settings tab

### NOTE

To access the **Device Settings** tab, see *Accessing the printer driver settings* on page 8.

You can auto detect the serial number in the **Device Settings** tab as follows.

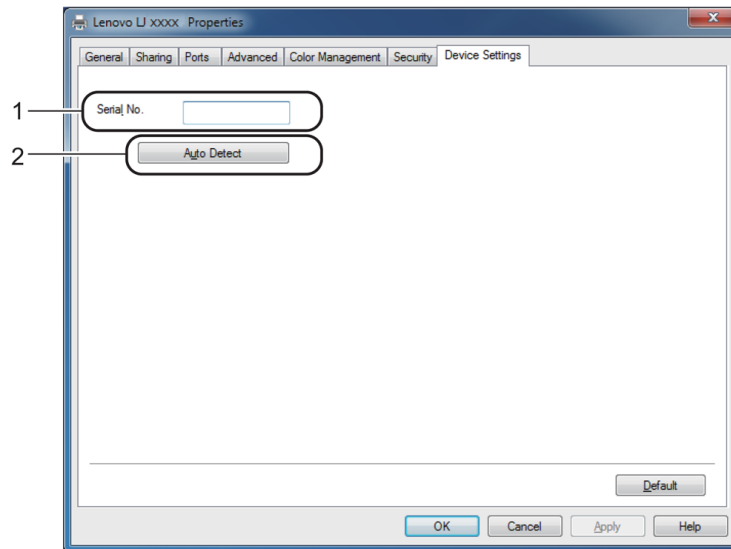

#### ■ Serial No. (1)

By clicking **Auto Detect** (2), the printer driver will probe the machine and display its serial number. If it fails to receive the information, the screen will display “-----”.

### NOTE

The **Auto Detect** (2) function is not available under the following machine conditions:

- The machine is turned off.
- The machine is in an error state.
- The machine is connected to the print server using a USB cable in a shared network environment.
- The cable is not connected to the machine correctly.

## Uninstalling the printer driver

---

You can uninstall the printer driver that you have installed with the following steps.

### NOTE

---

- This is not available if you originally installed the printer driver from the Windows® **Add a printer** function.
  - After uninstalling, we recommend that you restart your computer to remove files that were in use during the uninstall.
- 

- 1 (For Windows® XP, Windows Vista® and Windows® 7)  
Click the **Start** button, point to **All Programs, Lenovo**, and then click **Lenovo Utilities**.  
(For Windows® 8)

Click  (**Lenovo Utilities**).

- 2 Click the drop-down list and select your model name (if not already selected).
- 3 Click **Tools** in the left navigation bar.
- 4 Click **Uninstall**.
- 5 Follow the instructions on the screen.

## Status Monitor

The **Status Monitor** utility is a configurable software tool for monitoring the status of one or more devices, allowing you to get immediate notification of error messages.

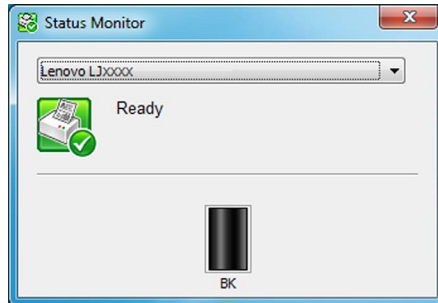



You can check the device status at anytime by double-clicking the icon in the taskbar or by choosing **Status Monitor** located in **Lenovo Utilities** on your PC.

(For Windows® XP, Windows Vista® and Windows® 7)

Click  (**Start**) > **All Programs** > **Lenovo** > **Lenovo Utilities**, and then click the drop-down list and select your model name (if not already selected). Click **Tools** in the left navigation bar, and then Click **Status Monitor**.

(Windows® 8)

Click  (**Lenovo Utilities**), and then click the drop-down list and select your model name (if not already selected). Click **Tools** in the left navigation bar, and then click **Status Monitor**.

To show the **Status Monitor** icon on your taskbar, click the  button. The **Status Monitor** icon will appear in the small window. Then drag the  icon to the taskbar.





## Monitoring the machine's status

The Status Monitor icon will change colour depending on the machine status.

- A green icon indicates the normal stand-by condition.



- A yellow icon indicates a warning.



- A red icon indicates a printing error has occurred.



There are two locations where you can display the **Status Monitor** on your PC - in the tasktray or on the desktop.

# Macintosh

## Features in the printer driver (Macintosh)

2

This machine supports OS X v10.7.5, 10.8.x, 10.9.x.

### NOTE

- The screens in this section are from OS X v10.7.5. The screens on your Macintosh will vary depending on your operating system version.
- The printer driver for Macintosh is available from the download page for your model on the Githon Support Website ([www.lenovoimage.com](http://www.lenovoimage.com)).

## Choosing page setup options

You can set the **Paper Size**, **Orientation** and **Scale**.

- 1 From an application such as TextEdit, click **File**, then **Page Setup**. Make sure **Lenovo LJXXXX** (where XXXX is your model name) is chosen in the **Format For** pop-up menu. You can change the settings for **Paper Size**, **Orientation** and **Scale**, then click **OK**.

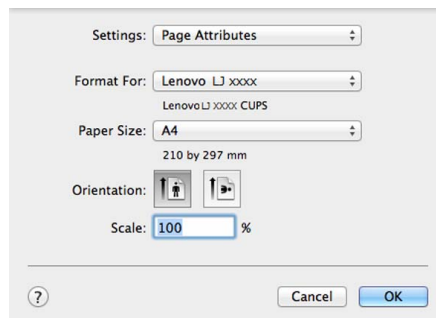

- 2 From an application such as TextEdit, click **File**, then **Print** to start printing.
  - For more page setup options, click the **Show Details** button.

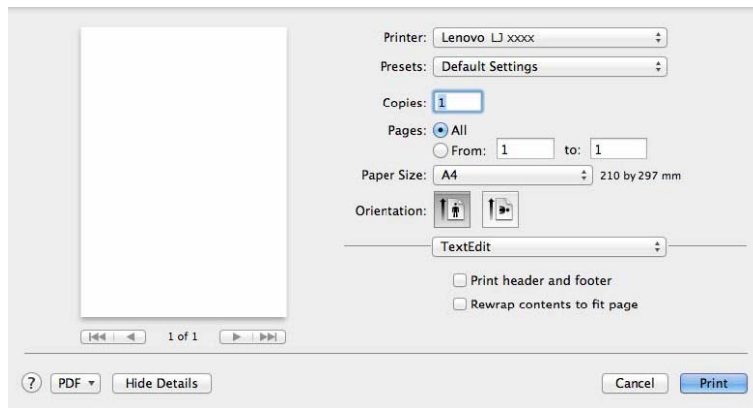
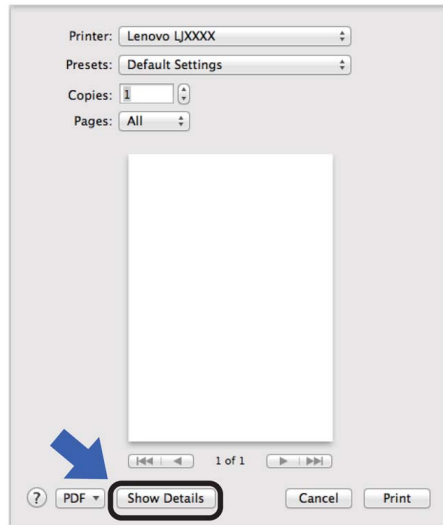

**NOTE**

You can save the current settings as a preset by choosing **Save Current Settings as Preset...** from the **Presets** pop-up menu.

## Choosing printing options

To control special printing features, choose **Print Settings** from the Print dialog box. For the details of available options, see the following descriptions of each option.

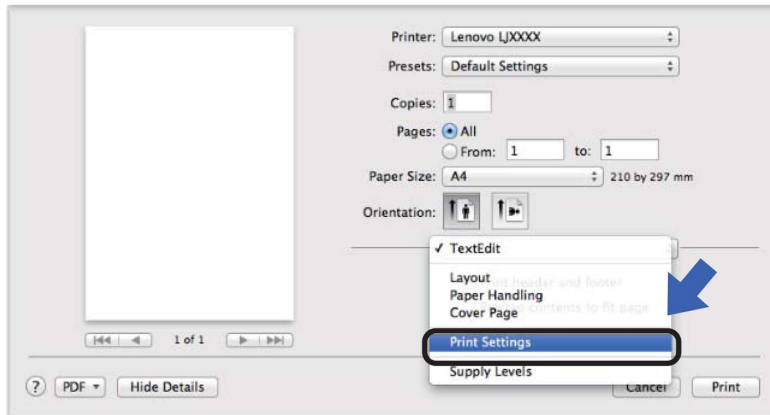

## Cover Page

You can choose the following cover page settings:

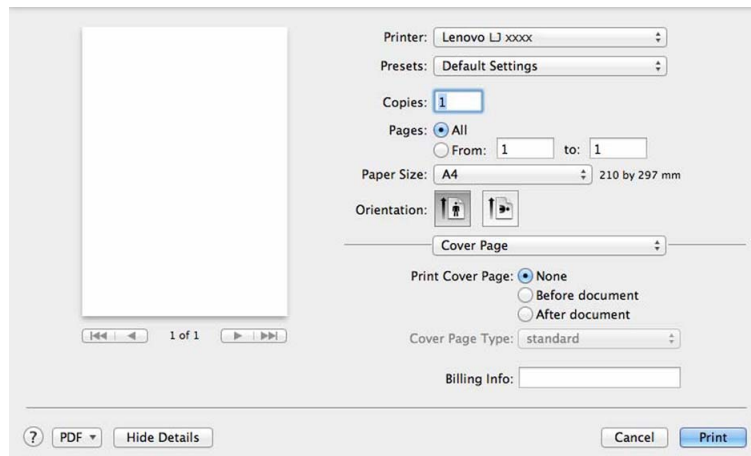

### ■ Print Cover Page

If you want to add a cover page to your document, use this function.

### ■ Cover Page Type

Choose a template for the cover page.

### ■ Billing Info

If you want to add the billing information to the cover page, enter text in the **Billing Info** box.

## Layout

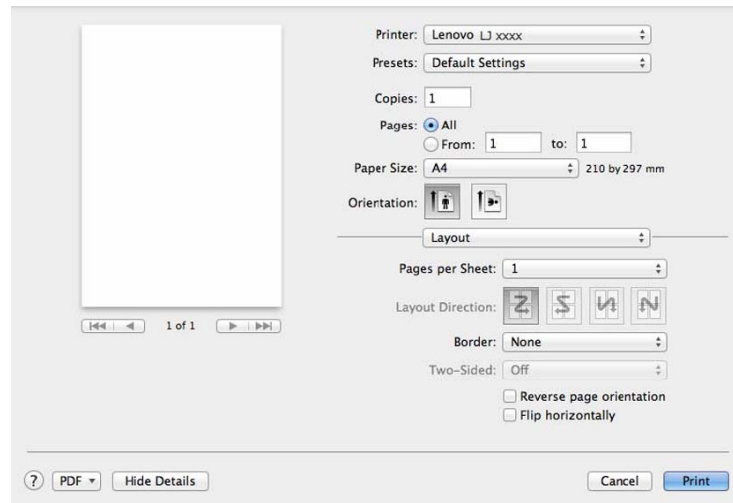

### ■ Pages per Sheet

The **Pages per Sheet** selection can reduce the image size of a page by allowing multiple pages to be printed on one sheet of paper.

### ■ Layout Direction

When you specify the pages per sheet, you can also specify the direction of the layout.

### ■ Border

If you want to add a border, use this function.

### ■ Reverse page orientation

Check **Reverse page orientation** to reverse the document 180 degrees.

### ■ Flip horizontally

Check **Flip horizontally** to print as a reflection flipped left-to-right.

## Print Settings

You can change settings by choosing a setting in the **Print Settings** list:

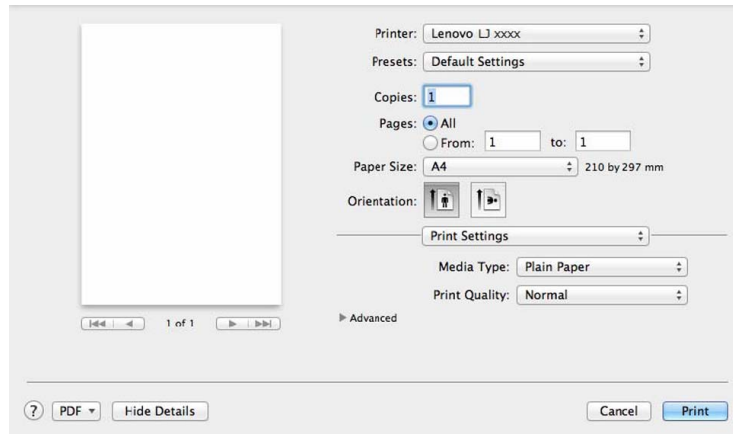

### ■ Media Type

You can change the media type to one of the following:

- Plain Paper
- Recycled Paper

### ■ Print Quality (For LJ2205 and LJ2206)

You can change the print quality as follows:

- Draft
- Normal
- Fine

### ■ Resolution (For LJ2206W)

You can change the resolution as follows:

- 300 dpi
- 600 dpi
- HQ 1200

## Advanced print settings

When you click the triangle mark (▶) beside **Advanced**, the advanced print settings appear.

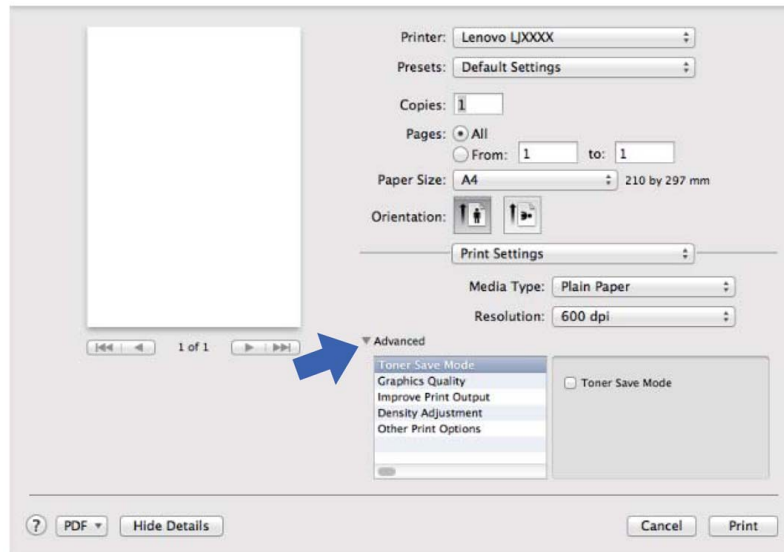

### ■ Toner Save Mode

You can conserve toner use with this feature. When you set **Toner Save Mode** to on, print appears lighter. The default setting is off.

## NOTE

- We do not recommend **Toner Save Mode** for printing Photo or Greyscale images.
- **Toner Save Mode** is not available for Fine for Print Quality <sup>1</sup> or **HQ 1200** for Resolution <sup>2</sup> is selected.

<sup>1</sup> For LJ2205 and LJ2206

<sup>2</sup> For LJ2206W

### ■ Graphics Quality

You can change the print quality as follows:

#### • Graphics

This is a graphics mode (contrast priority). Choose this setting for printing text and figures, such as business and presentation documents. You can represent sharp contrasts between shaded areas.

#### • Text

This is the best mode for printing text documents.

### ■ Improve Print Output

This feature allows you to improve a print quality problem.

#### • Reduce Paper Curl

If you choose this setting, the paper curl may be reduced.

If you are printing only a few pages, you do not need to choose this setting.

**NOTE**

This operation will decrease the temperature of the machine's fusing process.

- **Improve Toner Fixing**

If you choose this setting, the toner fixing capabilities may be improved.

**NOTE**

This operation will increase the temperature of the machine's fusing process.

- **Density Adjustment**

Increase or decrease the print density.

- **Other Print Options**

- **Skip Blank Page**

If **Skip Blank Page** is checked, the printer driver automatically detects blank pages and excludes them from printing.

**2-sided Printing**

- **Manual 2-sided Printing**

Select **Paper Handling**.

- Choose **Even Only** and **Print**. Reload the printed paper into the tray (blank side face up and the top page first). Choose **Odd Only** and **Print**.

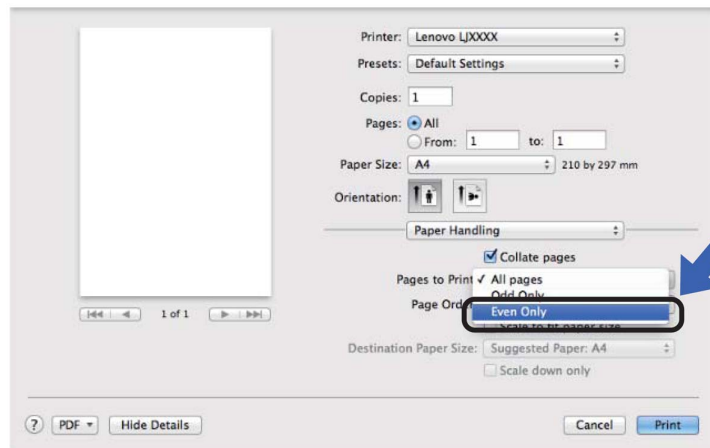
**Removing the printer driver**

- 1 Log in as an 'Administrator'.
- 2 From the Apple menu, choose **System Preferences**. Click **Print & Scan** or **Printers & Scanners**<sup>1</sup>, then choose the printer you want to remove and remove it by clicking the - button.
- 3 Click **Delete Printer**.

<sup>1</sup> **Printers & Scanners** for OS X v10.9.x users



## Status Monitor

The **Status Monitor** utility is a configurable software tool for monitoring the status of the machine, letting you see error messages at pre-set update intervals.

You can check the device status by launching Status Monitor following these steps:

- 1 Run the **System Preferences**, select **Print & Scan** or **Printers & Scanners**<sup>1</sup>, then choose the machine.
- 2 Click the **Options & Supplies....** Select the **Utility** tab then click **Open Printer Utility**. Status Monitor will start up.

<sup>1</sup> **Printers & Scanners** for OS X v10.9.x users

### Updating the machine's status

If you want the latest machine status while the **Status Monitor** window is open, click the Refresh  icon.

You can set the interval at which the software will update the machine status information. Go to the menu bar, **Status Monitor** and choose **Preferences**.

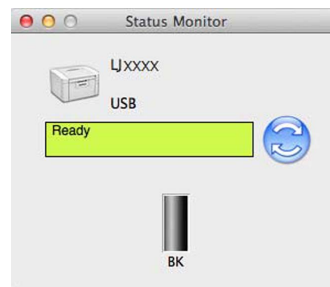

### Hiding or showing the window

After starting the **Status Monitor**, you can hide or show the window. To hide the window, go to the menu bar, **Status Monitor** and choose **Hide Status Monitor**. To show the window, click the **Status Monitor** icon in the dock.



### Quitting the window

Click **Status Monitor** in the menu bar and then choose **Quit Status Monitor** from the pop-up menu.

### **Web Based Management (Network Connection only)**

You can access Web Based Management by clicking the machine icon on the **Status Monitor** screen. A standard Web Browser can be used to manage your machine using HTTP (Hyper Text Transfer Protocol). More information on Web Based Management, see the Network User's Guide.

### **Software for networks (LJ2206W only)**

---

For the information about network utility software, see the Network User's Guide.

## Control panel

### LEDs (Light Emitting Diodes)

This section refers to two LEDs and two buttons on the control panel.

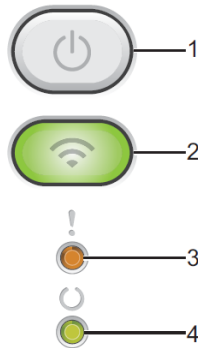

#### 1 Power On/Off

You can turn the machine on and off.

Press and hold down  to turn the machine on.

Press and hold down  to turn the machine off. All the LEDs turn off when you enable the Power Off mode.

Also, you can use the following functions:

Current Job Cancel / All Jobs Cancel

Error recovery / Form feed

For details, see *Power On/Off key* on page 40

#### 2 WiFi (LJ2206W only)

Press the **WiFi** button and launch the wireless installer on your computer. Follow the on-screen instructions to set up a wireless connection between your machine and your network.

When the **WiFi** light is on, your Lenovo machine is connected to a wireless access point. When the **WiFi** light blinks, the wireless connection is down, or your machine is in the process of connecting to a wireless access point.

#### 3 **Error LED (!)**



The **Error LED (!)** indicates that the machine is in error state.





Also, the **Error LED (!)** indicates the kind of error in combination with other LEDs.



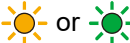

#### 4 **Ready LED (○)**







The **Ready LED (○)** will blink depending on the machine status.

The LED indications shown in the table below are used in the illustrations in this chapter.

	LED is off.
	LED is on.
	LED is dimmed.
	LED is blinking.

LEDs	Machine Status
	<p><b>Sleep</b></p> <p>The machine is in Sleep Mode (Power Save mode). While the machine is in Sleep Mode, the <b>Ready</b> LED (○) is dimmed, but the machine can still receive data. Receiving a print job will automatically wake up the machine to start printing.</p> <p>For more information, see <i>Sleep Time</i> on page 42.</p>
	<p><b>Deep Sleep</b></p> <p>The machine is in Deep Sleep Mode, reducing more power consumption than Sleep mode. While the machine is in Deep Sleep Mode, the <b>Ready</b> LED (○) is dimmed, but the machine can still receive data. Receiving a print job will automatically wake up the machine to start printing.</p> <p>For more information, see <i>Deep Sleep mode</i> on page 42.</p>
	<p><b>Ready</b></p> <p>The machine is ready to print.</p>
	<p><b>Printing</b></p> <p>The machine is printing.</p> <p>The <b>Ready</b> LED (○) will blink at 0.5 second intervals.</p>
	<p><b>Please Wait</b></p> <p>The machine is warming up.</p> <p>The <b>Ready</b> LED (○) will blink in 1 second intervals.</p>
	<p><b>Cooling Down</b></p> <p>The inside of the machine is extremely hot. The machine will pause its current print job and go into Cooling Down mode. Wait until the machine is in Ready mode.</p> <p>The <b>Ready</b> LED (○) will blink in 1 second intervals.</p>
	<p><b>Receiving Data</b></p> <p>The machine is either receiving data from the computer or processing data in the memory.</p> <p>The <b>Ready</b> LED (○) will blink in 0.5 second intervals.</p>
	<p><b>Data Remaining</b></p> <p>There is remaining print data in the machine's memory. If the <b>Ready</b> LED (○) is blinking for a long time and nothing has printed, press  to print the remaining data in the memory.</p> <p>The <b>Ready</b> LED (○) will blink in 0.5 second intervals.</p>

LEDs	Machine Status
	<p><b>Toner Low</b></p> <p>The toner cartridge will need to be replaced soon. Buy a new toner cartridge and have it ready for when <b>Replace Toner</b> is indicated.</p> <p>Both the <b>Ready</b> (○) and <b>Error</b> (!) LEDs will turn on together, then the <b>Error</b> LED (!) will turn off after 0.5 seconds and the <b>Ready</b> LED (○) will turn off after 1 second, they will then both be off for a further 1 second. This procedure is repeated until the error is corrected.</p> <p>If the printout is faint, hold the drum unit and toner cartridge assembly level with both hands and gently shake it from side to side several times to spread the toner evenly inside the cartridge.</p> <p><b>Replace Toner</b> (Continue mode)</p> <p>The machine continues printing until the LED indicates <b>Toner Ended</b>.</p> <p>Both the <b>Ready</b> (○) and <b>Error</b> (!) LEDs will turn on together, then the <b>Error</b> LED (!) will turn off after 0.5 seconds and the <b>Ready</b> LED (○) will turn off after 1 second, they will then both be off for a further 1 second. This procedure is repeated until the error is corrected.</p> <p>For details about Continue mode, see <i>Toner Setting</i> on page 44.</p>
	<p><b>Replace Toner</b> (Stop mode)</p> <p>Replace the toner cartridge with a new one.</p> <p>The <b>Error</b> LED (!) will blink once in 1.5 seconds intervals.</p> <p>For details about Stop mode, see <i>Toner Setting</i> on page 44.</p> <p>(See the instructions printed on the box of the new toner cartridge.)</p> <p><b>No Toner</b></p> <p>Remove the drum unit and toner cartridge assembly, remove the toner cartridge from the drum unit, and re-install the toner cartridge back into the drum unit again. Re-install the drum unit and toner cartridge assembly back in the machine. If the problem continues, replace the toner cartridge.</p> <p>The <b>Error</b> LED (!) will blink once in 1.5 seconds intervals.</p> <p>(See the instructions printed on the box of the new toner cartridge.)</p> <p><b>Toner Ended</b></p> <p>Replace the toner cartridge with a new one.</p> <p>The <b>Error</b> LED (!) will blink once in 1.5 seconds intervals.</p> <p>(See the instructions printed on the box of the new toner cartridge.)</p>
	<p><b>Cartridge Error</b></p> <p>The drum unit and toner cartridge assembly is not installed correctly. Take the drum unit and toner cartridge assembly out of the machine and put it back in. Use only a genuine Lenovo Original drum unit and genuine Lenovo Original toner units.</p> <p>The <b>Error</b> LED (!) will blink 4 times and turn off for 1 second.</p>
	<p><b>Drum End Soon / Replace Drum</b></p> <p>Replace the drum with a new one. Reset the drum counter. (See the insertion included with the drum unit.)</p> <p>We recommend you keep a Lenovo Original drum unit ready for installation.</p> <p>The <b>Error</b> LED (!) will blink 3 times at 0.5 second intervals and the <b>Ready</b> LED (○) will light up. Then both LEDs will turn off for 1 second.</p>

LEDs	Machine Status
	<p><b>Drum !</b></p> <p>The corona wire needs to be cleaned. See <i>Cleaning the corona wire on Improving the print quality</i>. The <b>Error LED (!)</b> will blink 3 times and turn off for 1 second.</p>
	<p><b>No Drum</b></p> <p>If the toner cartridge is placed in the machine without the drum unit, put the toner cartridge into the drum unit, and then reinstall the drum unit and toner cartridge assembly in the machine. The <b>Error LED (!)</b> will blink 3 times and turn off for 1 second.</p>
	<p><b>Jam Tray / Jam Inside 1 / Jam Inside 2 / Jam Inside 3</b></p> <p>Clear the paper jam. See <i>Paper jams</i> on page 51.</p> <p>If the machine does not start printing, press .</p> <p>The <b>Error LED (!)</b> will blink twice and turn off for 1 second.</p>
	<p><b>Wrong Paper Type</b></p> <p>The width or length of the paper in the paper tray is too small. Put paper that can be used in the paper tray, and then press .</p> <p>Acceptable paper sizes are: A4, Letter, Legal, Folio, A5, A5(Long Edge), B5, Executive, 16K(195x270mm), 16K(184x260mm) and 16K(197x273mm). (See <i>Acceptable paper</i> on page 2.) The <b>Error LED (!)</b> will blink twice and turn off for 1 second.</p>
	<p><b>No Paper</b></p> <p>Put paper in the paper tray you are using. The <b>Error LED (!)</b> will blink twice and turn off for 1 second.</p>
	<p><b>Size Mismatch</b></p> <p>The paper in the tray is not the correct size. Load the correct size of paper in the tray and set the size of paper to the tray. The <b>Error LED (!)</b> will blink twice.</p> <p><b>Cover is Open</b></p> <p>Close the top cover of the machine. The <b>Error LED (!)</b> will blink 4 times and turn off for 1 second.</p>
	<p><b>Out of Memory</b></p> <p>Press and hold  for about 2 seconds until all the LEDs light up and then release it. The machine will cancel the print job and clear it from the memory. The machine also cancels the print job and clears it from the memory automatically one minute after entering the <b>Out of Memory</b> state. Reduce the complexity of your document or lower the print quality. The <b>Error LED (!)</b> will blink 4 times and turn off for 1 second.</p>
	<p><b>Job Cancel</b></p> <p>The machine is canceling the job. The <b>Error LED (!)</b> and <b>Ready LED (C)</b> will light up alternately.</p>

## Service call indications

If there is an error that cannot be cleared by the user, the machine will show that a service call is needed by lighting up all the LEDs as shown below.



If you see the service call indication shown above, turn off the machine, and then turn it back on and try to print again.

If the error is not cleared after turning the machine off and then back on, press . The LEDs will light up as shown in the following table to identify the error. The number under the LED icon shows how many times the LED will blink.

### LED error indication

LEDs	Main PCB failure	Fuser unit failure <sup>1</sup>	Laser unit failure	Main motor failure	High voltage failure	Zero Cross error
<b>Error</b>						
<b>Ready</b>	 (7)/(4)	 (3)	 (5)	 (6)	 (2)	 (1)

<sup>1</sup> If this error occurs, turn off the machine, wait a few seconds, and then turn it on again. Leave the machine for approx. 15 minutes with the power on. If the error occurs again, call your Lenovo Call Center or your local authorized repair station.

For example, the LED indication below shows a fuser unit failure.

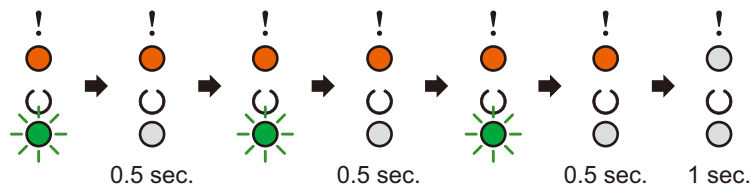

Make a note of the indication, referring to *LED error indication* on page 39, and report the error status to Lenovo Call Center or your local authorized repair station.

### NOTE

Make sure that the top cover is completely closed before you report a service call.

## Power On/Off key

---

Power On/Off key has the following functions:

### ■ Power Off

Make sure that the machine is in the **Ready** mode, then hold down  for about 2 seconds. All the LEDs turn off when you enable the Power Off mode. For details about Power Off mode, see *Auto Power Off* on page 42.

### ■ Cancel printing

Cancel the current job being printed: Press and hold  for about 2 seconds. The machine will then eject the paper. The **Error** LED (!) and **Ready** LED (○) will light up alternately. Then release .

Cancel all the received jobs (LJ2205 and LJ2206 only): To delete all jobs, cancel the current job first following the procedure above. While all the LEDs light up alternately, press  again. All the LEDs will keep on lighting up alternately as the job(s) is being canceled.

### ■ Error recovery

If there is an error, the machine will recover automatically from some errors. If an error is not automatically cleared, press  to clear the error, and then continue to use the machine.

### ■ Form feed

If the **Ready** LED (○) blinks for a long time, press . The machine will print any data that is left in the machine's memory.



## Print a Printer Settings page

You can print the current settings using the control panel button or printer driver.

### Using the Power On/Off key

---

- 1 Make sure that the top cover is closed and the power cord is plugged in.
- 2 Turn on the machine and wait until the machine is in Ready mode.
- 3 Press  three times. The machine will print the current printer settings page.

### Using the printer driver

---

If you are using the Windows<sup>®</sup> printer driver, you can print the current printer settings page by clicking the **Print Settings** button in the **Support** dialog box.

## Ecology features

### Toner Save

---

You can save toner using this feature. When you set Toner Save to on, prints appear lighter. The default setting is off.

You can change the toner save mode setting on the printer driver.

To change the toner save mode setting, see the following:

- *Advanced tab* on page 14 (Windows® printer driver)
- *Print Settings* on page 30 (Macintosh printer driver)

### Sleep Time

---

The Sleep mode setting can reduce power consumption. The machine will wake up and start printing when it receives a print job.

The machine automatically goes into Sleep mode after it is idle for 1 minute. When the machine receives a print file or document, the timer will be reset. While the machine is in Sleep mode the **Ready** LED (○) glows dimly.

### Deep Sleep mode

---

If the machine is in Sleep mode and does not receive any jobs for a certain length of time, the machine will go into Deep Sleep mode automatically and the **Ready** LED (○) glows dimly. Deep Sleep mode uses less power than Sleep Mode. The machine will wake up, when the machine receives a print job.

### Auto Power Off

---

If the machine is in Deep Sleep mode for 1 hour, it enters Power Off mode automatically. Power Off mode is the lowest power consumption mode, which achieves a power consumption of less than 0.28 W. To start printing, hold  key on the control panel until all the LEDs light up. Then send the print data.

#### NOTE

---

LJ2206W

You can change the Auto Power Off setting through Web Based Management. For more information, see the Network User's Guide.

The machine does not go into Power Off mode when the machine is connected to a wireless network.

---

## Consumable items

The drum unit and toner cartridge are two separate consumables. Make sure both are installed as an assembly. For more information on how to replace the consumable items, see the instructions included with the drum unit for replacing the drum unit or see the instructions listed on the box of the toner cartridge for replacing the toner cartridge.

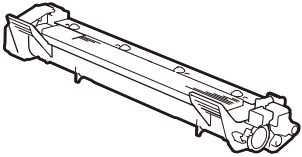
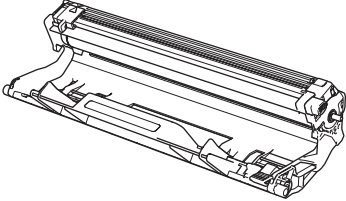
Toner cartridge	Drum unit
Model Name: LT201	Model Name: LD201
	

### IMPORTANT

- Lenovo machines are designed to work with toner of a particular specification and will work to a level of optimum performance when used with Lenovo Original toner cartridges. Lenovo cannot guarantee this optimum performance if toner or toner cartridges of other specifications are used. The machine may not detect toner or toner cartridges of other specifications correctly but may instead detect such items as standard yield toner cartridges. Lenovo does not therefore recommend the use of cartridges other than Lenovo Original cartridges with this machine, or the refilling of empty cartridges with toner from other sources. If damage is caused to the drum unit or other parts of this machine as a result of the use of toner or toner cartridges other than Lenovo Original products due to the incompatibility or lack of suitability of those products with this machine, any repairs required as a result may not be covered by the warranty.
- For best performance, use a Lenovo Original drum unit and Lenovo Original toner units. Printing with a third party drum unit or toner unit may reduce not only the print quality but also the quality and life of the machine itself. Warranty coverage may not apply to problems caused by the use of a third party drum or toner unit.

### NOTE

Discard used consumable items according to local regulations, keeping it separate from domestic waste. If you have questions, call your local waste disposal office. Be sure to reseal the consumable items tightly so that the material inside does not spill.

## Toner Setting

The printing operation varies depending on the machine setting:

■ Default setting (Stop mode)

The machine will stop printing until you replace the toner cartridge with a new one when the LEDs indicate **Replace Toner**.

■ Continue mode

To force the machine to continue printing after the LEDs indicate **Replace Toner**, press  seven times to enter Continue mode (all the LEDs blink twice, and then the **Ready** LED (○) turns on). The machine will continue printing until the LEDs indicate **Toner Ended**.

To return to the default setting (Stop mode), press  seven times (all the LEDs blink once).

### NOTE

---

- Make sure that the top cover is closed before you change the mode.
  - When the LEDs indicate an error mode, you cannot change the mode.
  - If you continue printing in the Continue mode, we cannot guarantee the print quality.
  - While using Continue mode the print may appear faint.
-

## Identifying your problem

First, check the following.

- The machine's power cord is connected correctly and the machine is turned on.
- All of the protective parts have been removed.
- Paper is inserted correctly in the paper tray.
- The interface cable is securely connected to the machine and the computer.

If you did not solve your problem with the above checks, identify your problem and then go to the page suggested below:

*If you are having difficulty with your machine on page 55*

*Improving the print quality on page 47*

If the machine is connected to a PC, depending on the error, a Popup application may appear on the PC. Follow the instructions on the screen to resolve the error.

## Error messages in the Status Monitor

The most common error and maintenance messages are shown below.

If you need more help, the Githon Support Website offers the latest FAQs and troubleshooting tips: Visit us at [www.lenovoimage.com](http://www.lenovoimage.com).

Error message	Cause	Action
<b>Cartridge Error</b>	The toner cartridge is not installed correctly.	Pull out the drum unit and toner cartridge assembly, take out the toner cartridge, and put it back into the drum unit again. Put the drum unit and toner cartridge assembly back in the machine. If the problem continues, call your local authorized repair station.
	Verify you are using a genuine Lenovo toner cartridge.	Use only a genuine Lenovo Original drum unit and genuine Lenovo Original toner cartridge.
<b>Cooling Down</b>	The inside of the machine is extremely hot.	The machine will pause its current print job and go into Cooling Down mode. Wait until the machine is in Ready mode.
<b>Cover is Open</b>	The top cover is not closed completely.	Close the top cover of the machine.
<b>Drum End Soon</b>	The drum unit is near the end of its life.	Order a new drum unit now so a replacement drum unit will be available when the <b>Status Monitor</b> indicates <b>Replace Drum</b> . (See <i>Drum End Soon / Replace Drum on LEDs (Light Emitting Diodes)</i> .)
<b>Replace Drum</b>	It is time to replace the drum unit.	Replace the drum unit.  (See the instructions that are supplied with the new drum unit.)
	The drum unit counter was not reset when a new drum was installed.	Reset the drum unit counter.  (See the instructions that are supplied with the new drum unit.)
<b>Replace Toner</b>	The toner cartridge is at the end of its life. The machine will stop all print operations.	Replace the toner cartridge.  (See the instructions printed on the box of the new toner cartridge.)
<b>Toner Low</b>	If the <b>Status Monitor</b> shows <b>Toner Low</b> you can still print; however, the machine is telling you that the toner cartridge is near the end of its life.	Order a new toner cartridge now so a replacement toner cartridge will be available when the <b>Status Monitor</b> shows <b>Replace Toner</b> .

## Improving the print quality

### NOTE

Lenovo does not recommend the use of cartridges other than genuine Lenovo Original cartridges or the refilling of used cartridges with toner from other sources.

If you are having problems with print results, check the following:

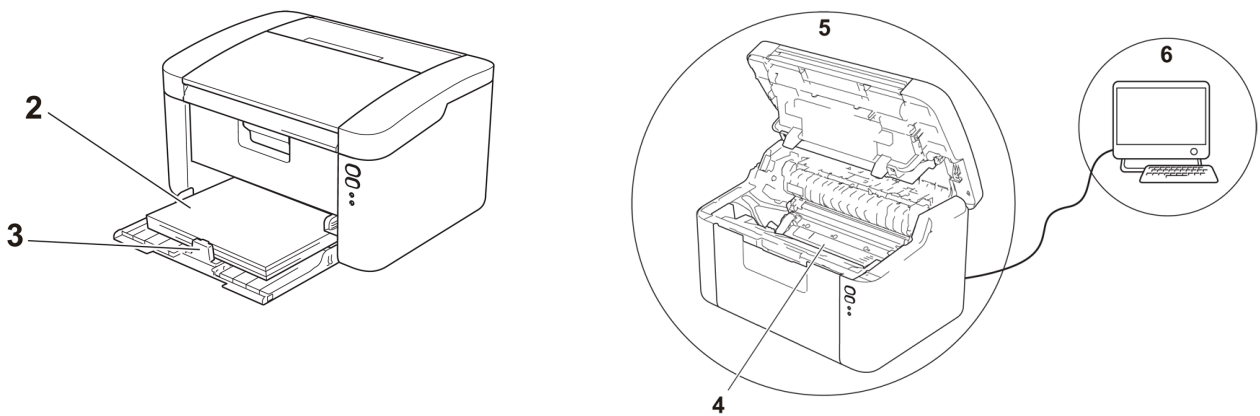

1 The machine's environment.

Choose a location where the temperature remains between 10°C and 32°C and the humidity is between 20% to 80% (without condensation).

2 Acceptable paper is loaded in the paper tray.

See *Acceptable paper* on page 2

3 The paper is loaded correctly in the machine.

Turning the paper over may help paper loading become smoother.

Adjusting the guide may help paper loading become smoother.

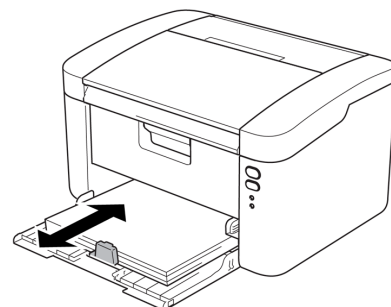
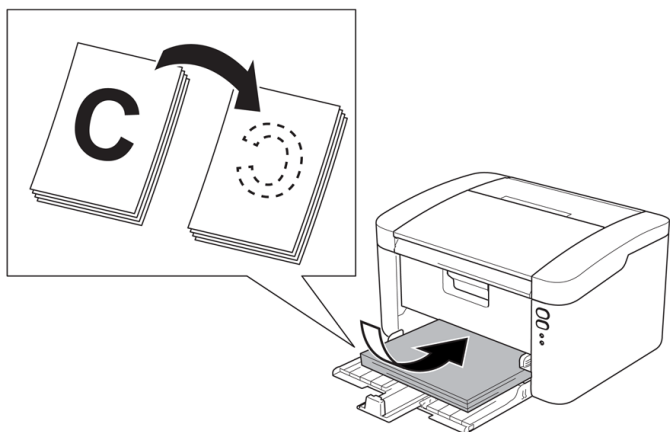

4 Replace a toner cartridge or a drum unit.

For more information on how to replace the consumable items, see the instructions included with the drum unit for replacing the drum unit or see the instructions listed on the box of the toner cartridge for replacing the toner cartridge.

5 Clean the inside of the machine.

■ Cleaning the corona wire

Slide the green tab from left to right and right to left several times.

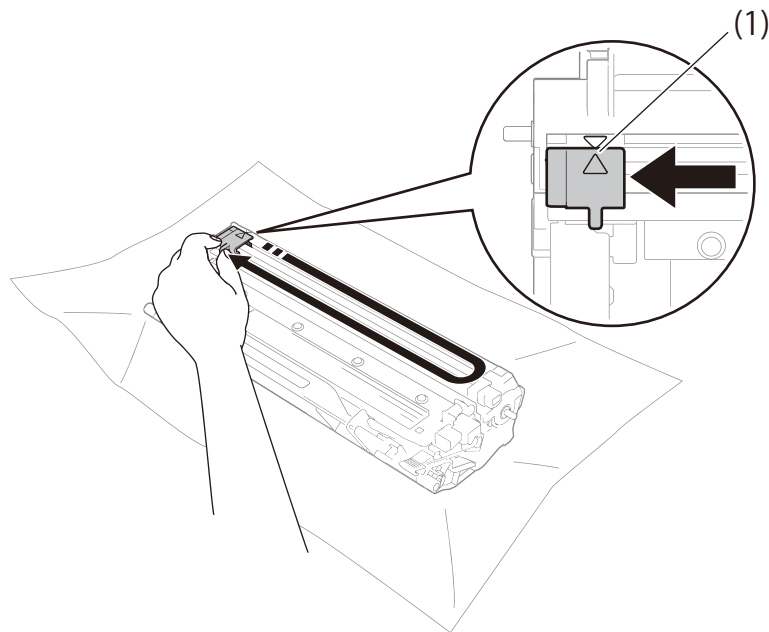

**NOTE**

Be sure to return the tab to the home position (▲) (1). If you do not, printed pages may have a vertical stripe.

■ Clean the drum unit if black or white dots appear on printed pages

Push down the lock lever and take the toner cartridge out of the drum unit.

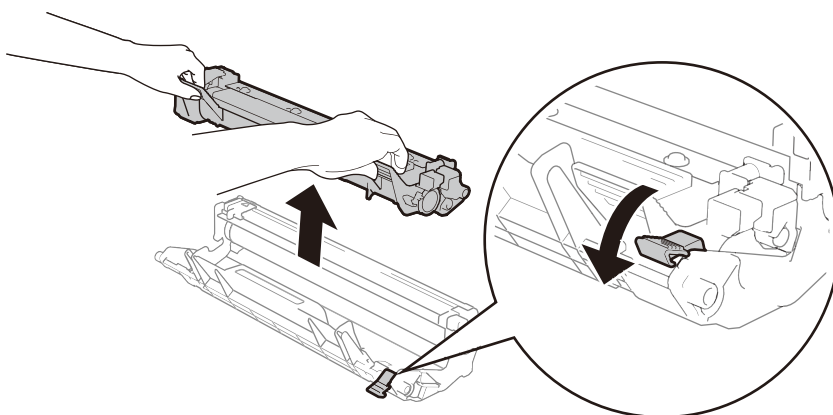



Turn the drum unit gear by hand while looking at the surface of the drum roller (1).

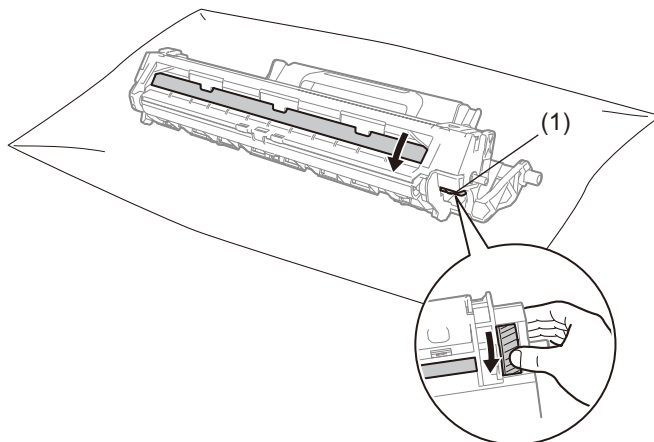

Wipe the surface of the drum gently with a dry cotton swab until the dust or glue on the surface comes off.

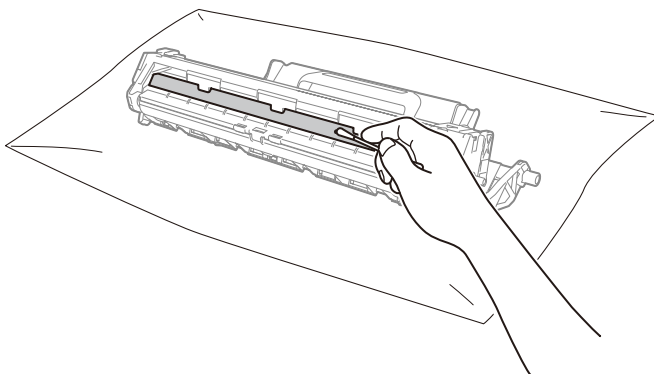

6 Check the printer driver settings.

Try changing the **Print Settings** in **Basic** tab.

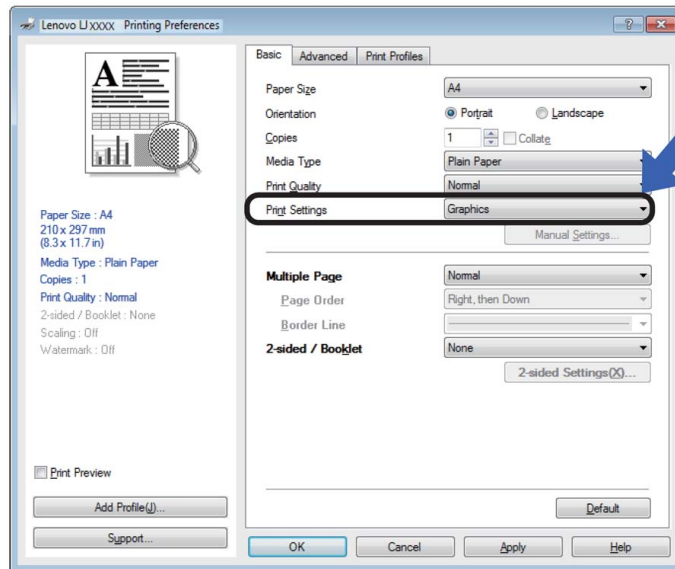

If the paper is curled or the toner is not fixed well on the paper, you can adjust these settings in **Improve Print Output**. Click **Other Print Options** in the **Advanced** tab.

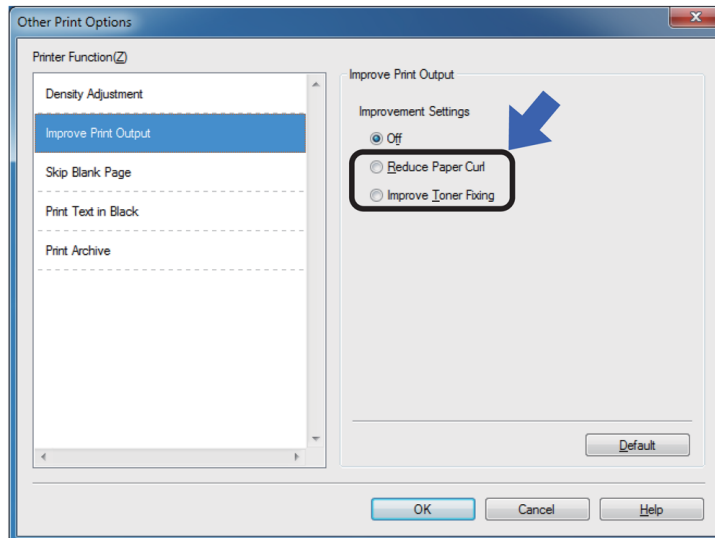

## Paper jams

If a paper jam occurs inside the machine or the paper tray, the **Error** LED (!) will blink twice.



- 1 Leave the machine turned on for 15 minutes for the product to cool down before you touch the internal parts of the product.
- 2 Use both hands to slowly pull out the jammed paper.



- 3 Open the top cover.

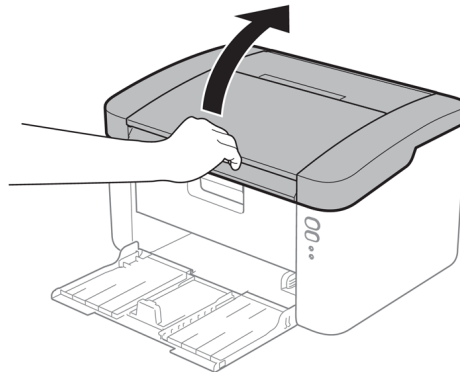

A

- 4 Slowly take out the drum unit and toner cartridge assembly. The jammed paper may be pulled out with the drum unit and toner cartridge assembly, or this may release the paper so you can pull it out from inside of the machine.

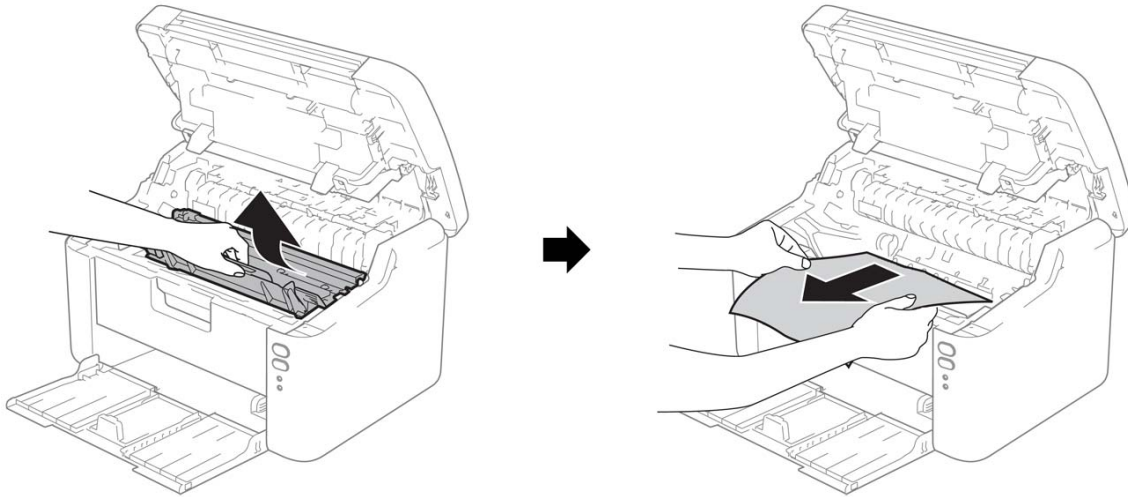

A

 **WARNING**

 **HOT SURFACE**

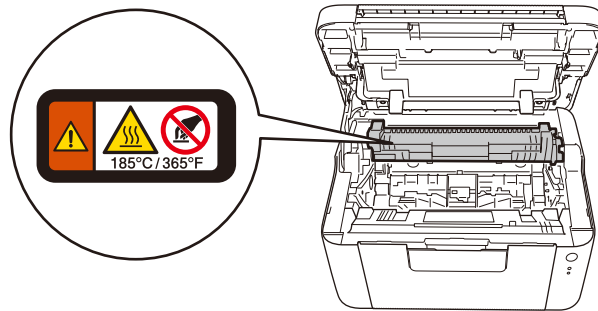

- 5 Push down the lock lever and take the toner cartridge out of the drum unit. Remove the jammed paper if there is any inside the drum unit.

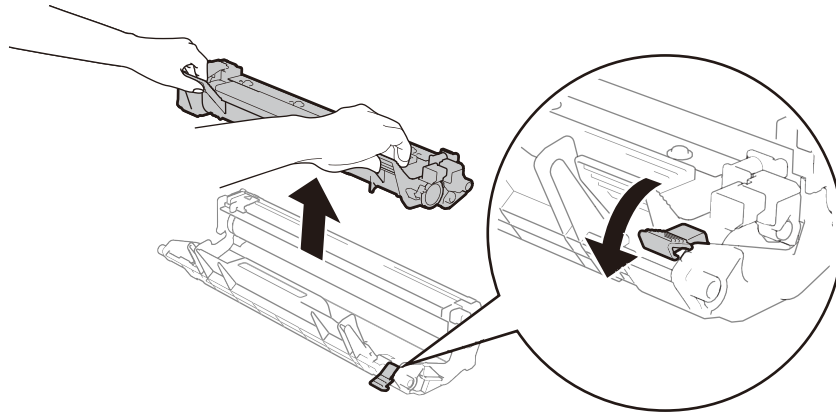

- 6 Put the toner cartridge back into the drum unit until you hear it lock into place. If you put the cartridge in correctly, the lock lever on the drum unit will lift automatically.

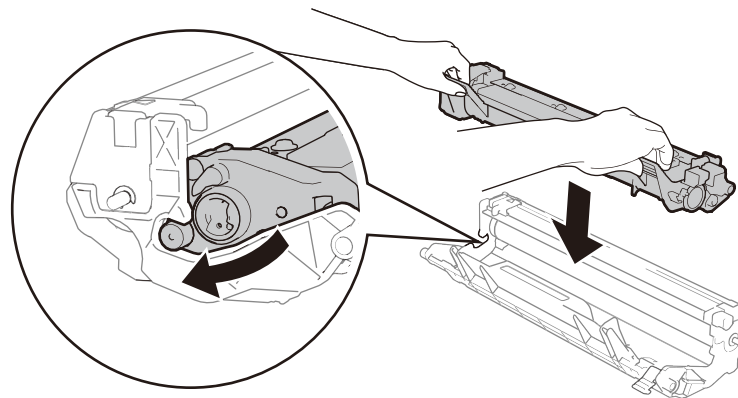

- 7 Put the drum unit and toner cartridge assembly back into the machine.

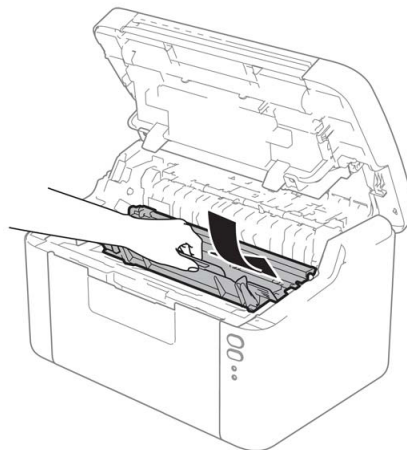

- 8 Close the top cover of the machine.

- 9 Make sure that the paper is below the protruding section of the red rear guide. Slide the paper guides to fit the paper size. Make sure that the guides are firmly in the slots.

## NOTE

---

If you turn off the machine during paper jam, the machine will print incomplete data from your computer when you turn the machine back on. Before you turn on the machine, delete the print spool job on your computer.

---

- 10 Make sure that the **Error** LED (!) is off and that the **Ready** LED (○) is green.



## If you are having difficulty with your machine

### IMPORTANT

- For technical help, you must call the country where you bought the machine. Calls must be made from within that country.
- If you think there is a problem with your machine, check the chart below and follow the troubleshooting tips. Most problems can be easily resolved by yourself.
- If you need additional help, the Githon Support Website offers the latest FAQs and troubleshooting tips. Visit us at [www.lenovoimage.com](http://www.lenovoimage.com).



### Printing difficulties

Difficulties	Suggestions
No printout.	<p>Check that the correct printer driver has been installed and chosen.</p> <p>Check to see if the LEDs are indicating any error. (See <i>LEDs (Light Emitting Diodes)</i> on page 35 and <i>Error messages in the Status Monitor</i> on page 46.)</p> <p>Check the machine is online:</p> <p>(For Windows Server® 2012 R2) Click <b>Control Panel</b> on the <b>Start</b> screen. In the Hardware and Sound group, click <b>View devices and printers</b>. Right-click <b>Lenovo LJXXXX</b>. Click <b>See what's printing</b>. If printer driver options appear, select your printer driver. Click <b>Printer</b> in the menu bar and make sure <b>Use Printer Offline</b> is not selected.</p> <p>(For Windows® 8 and Windows Server® 2012) Move your mouse to the lower right corner of your desktop. When the menu bar appears, click <b>Settings</b>, and then click <b>Control Panel</b>. In the <b>Hardware and Sound</b> group, click <b>View devices and printers</b>. Right-click <b>Lenovo LJXXXX</b> and click <b>See what's printing</b>. Click <b>Printer</b> and make sure <b>Use Printer Offline</b> is unchecked.</p> <p>(Windows® 7 and Windows Server® 2008 R2) Click the  (<b>Start</b>) button and <b>Devices and Printers</b>. Right-click <b>Lenovo LJXXXX</b> and click <b>See what's printing</b>. Click <b>Printer</b> and make sure <b>Use Printer Offline</b> is unchecked.</p> <p>(Windows Vista® and Windows Server® 2008) Click the  (<b>Start</b>) button, <b>Control Panel</b>, <b>Hardware and Sound</b>, and then <b>Printers</b>. Right-click <b>Lenovo LJXXXX</b>. Make sure that <b>Use Printer Offline</b> is deselected. If it is listed, click this option to set the driver Online.</p> <p>(Windows® XP and Windows Server® 2003) Click the <b>Start</b> button and choose <b>Printers and Faxes</b>. Right-click <b>Lenovo LJXXXX</b>. Make sure that <b>Use Printer Offline</b> is deselected. If it is listed, click this option to set the driver Online.</p>

## Printing difficulties (continued)

Difficulties	Suggestions
The machine is not printing or prints unexpectedly.	<p>Press and hold  for about 2 seconds until all the LEDs light up and then release it.</p> <p>The machine will cancel the print job and clear it from the memory. The printout may be incomplete.</p>

## Network difficulties

Difficulties	Suggestions
The Lenovo software cannot be installed.	<p>(Windows®)</p> <p>If the Security Software warning appears on the PC screen during the installation, change the Security Software settings to permit the Lenovo product setup program or other program to run.</p> <p>(Macintosh)</p> <p>If you are using a firewall function of anti-spyware or antivirus security software, temporarily disable it and then install the Lenovo software.</p>
Cannot connect to wireless network.	Investigate the problem using the WLAN Report. To print the WLAN Report, see Network User's Guide.
For other problems concerning using your machine on a Network, see Network User's Guide	

A



## Cleaning and Checking the machine

Clean the outside and inside of the machine regularly with a dry, lint-free cloth. When you replace the toner cartridge or the drum unit, make sure that you clean the inside of the machine. If printed pages are stained with toner, clean the inside of the machine with a dry, lint-free cloth.

### **WARNING**



DO NOT use flammable substances, any type of spray, or an organic solvent/liquid containing alcohol or ammonia to clean the inside or outside of the machine. Doing so could cause a fire or electrical shock. Instead, use only a dry, lint-free cloth.

(See Product Safety Guide)



# Machine Information

## Default settings

---

The machine has three levels of default settings; the default settings have been set at the factory before shipment.

- Network Reset (LJ2206W only)
- Factory Reset
- Settings Reset



### NOTE

---

- You cannot modify the preset default settings.
  - Page counters can never be changed.
- 



### Network Reset (LJ2206W only)

To reset only the print server back to its default settings (by resetting all network information such as the password and IP address), follow these steps:

- 1 Turn the machine off.
- 2 Make sure that the top cover is closed and the power cord is plugged in.
- 3 While holding down , open and close the top cover once.
- 4 Release . Make sure that all the LEDs turn off.
- 5 Press  six times. Make sure that all the LEDs light up to indicate the machine has been reset to its network default settings. The machine will restart.



### Factory Reset

You can partially reset the machine back to its default printer settings:

- 1 Turn off the machine.
- 2 Make sure that the top cover is closed and the power cord is plugged in.
- 3 While holding down , open and close the top cover once.
- 4 Release . Make sure that all the LEDs turn off.
- 5 Press  eight times. Make sure that all the LEDs light up to indicate the machine has been reset to its factory default settings. The machine will restart.

## Settings Reset

This operation will reset all the machine settings back to the settings that were set at the factory:

- 1 Turn off the machine.
- 2 Make sure that the top cover is closed and the power cord is plugged in.
- 3 While holding down , open and close the top cover once.
- 4 Release . Make sure that all the LEDs turn off.
- 5 Press  ten times. The machine will automatically restart.

# B

## Specifications

### General

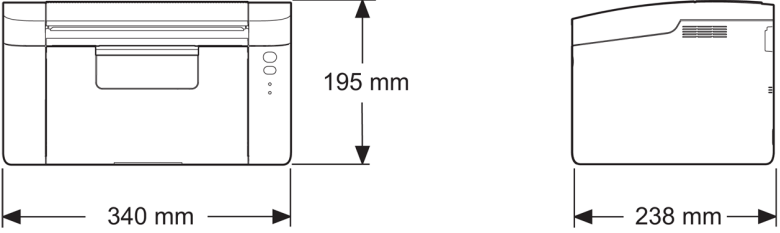
Model			LJ2205	LJ2206	LJ2206W
Printer Type			Laser		
Print Method			Electrophotographic Laser Printer		
Memory Capacity	Standard		1 MB		32MB
Power Source			220 - 240 V AC 50/60 Hz		
Power Consumption (Average)	Peak <sup>1</sup>		Approx. 1,056 W		
	Printing <sup>1</sup>		Approx. 380 W at 25 °C		
	Ready <sup>1</sup>		Approx. 40 W at 25 °C		
	Deep Sleep <sup>1</sup>		Approx. 0.5 W		Approx. 0.7 W
	Power Off <sup>1 2 3</sup>		Approx. 0.28 W		
Dimension					
Weights (with consumables)			4.6 kg		4.7 kg
Noise Level	Sound Pressure	Printing	LPAm = 51 dB (A)		
	Sound Power <sup>4 5</sup>	Printing	LWAd = 6.6 B (A)		

B

Model		LJ2205	LJ2206	LJ2206W
Temperature	Operating	10 to 32 °C <sup>6</sup>		
	Storage	0 to 40 °C		
Humidity	Operating	20 to 80% (without condensation)		
	Storage	35 to 85% (without condensation)		
Interface	USB	Full-Speed USB 2.0 <sup>7 8</sup> It is recommended you use a USB 2.0 cable (Type A/B) that is no more than 2.0 metres long.	Hi-Speed USB 2.0 <sup>7 8</sup> It is recommended you use a USB 2.0 cable (Type A/B) that is no more than 2.0 metres long.	
	Wireless LAN <sup>9</sup>	—	IEEE 802.11 b/g/n (Infrastructure mode/Ad-hoc mode)	
Support OS	Windows <sup>®</sup>	Windows <sup>®</sup> XP Home, Windows <sup>®</sup> XP Professional, Windows <sup>®</sup> XP Professional x64 Edition, Windows Vista <sup>®</sup> , Windows <sup>®</sup> 7, Windows <sup>®</sup> 8, Windows <sup>®</sup> 8.1, Windows Server <sup>®</sup> 2003, Windows Server <sup>®</sup> 2003 x64 Edition, Windows Server <sup>®</sup> 2008, Windows Server <sup>®</sup> 2008 R2, Windows Server <sup>®</sup> 2012, Windows Server <sup>®</sup> 2012 R2		
	Mac OS	OS X v10.7.5, 10.8.x, 10.9.x		
Consumables	Toner Cartridge (Inbox)		Approx. 1,500 pages A4 or Letter page <sup>10</sup>	
	Toner Cartridge (Standard)		Approx. 1,500 pages A4 or Letter page <sup>10</sup>	
		Model Name	LT201	
	Drum Unit		Approx. 10,000 pages A4 or Letter pages (1 page / job) <sup>11</sup>	
		Model Name	LD201	

<sup>1</sup> Measured when the machine is connected to the USB interface.

<sup>2</sup> Power consumption varies slightly depending on the usage environment or part wear.

<sup>3</sup> Measured according to IEC 62301 Edition 2.0.

<sup>4</sup> Measured in accordance with the method described in RAL-UZ171.

<sup>5</sup> Office equipment with LWAd>6.30 B (A) is not suitable for use in rooms where people require high levels of concentration. Such equipment should be placed in separate rooms because of noise emission.

<sup>6</sup> To ensure the high print quality, the maximum ambient temperature we recommend is 32 °C. The maximum ambient temperature to safely use this machine is 35 °C.

<sup>7</sup> The machine can also be connected to a computer that has a USB 1.1 interface.

<sup>8</sup> Third-party USB ports are not supported.

<sup>9</sup> For detailed network specifications, see *Network (LAN) (LJ2206W only)* on page 65 and *Network User's Guide*.

<sup>10</sup> Approx. cartridge yield is declared in accordance with ISO/IEC 19752.

<sup>11</sup> Drum life is approximate and may vary by type of use.

## Print media

Model		LJ2205	LJ2206	LJ2206W
Paper Input	Paper Tray	Paper Type	Plain paper, Recycled paper	
		Paper Size	A4, Letter, Legal, Folio, A5, A5(Long Edge), B5(JIS), Executive, 16K(195x270mm), 16K(184x260mm), 16K(197x273mm) Width: 148 to 216 mm Length: 148 to 355.6 mm	
		Paper Weight	65 to 105 g/m <sup>2</sup>	
		Maximum Paper Capacity	Up to 150 sheets of 80 g/m <sup>2</sup> Plain paper	
Paper Output	Face-Down Output Tray	Up to 50 sheets of 80 g/m <sup>2</sup> Plain paper (face- down delivery to the face- down output paper tray)		

## Important information for choosing your paper

The information in this section will help you choose paper to use with this machine.

### NOTE

If you use paper that is not recommended, a paper jam or misfeed may occur in the machine.

### Before you buy a large quantity of paper

Make sure that the paper is suitable for the machine.

### Paper for plain paper copies

Paper is divided by usage, such as paper for printing and paper for copying. The usage is usually written on the paper's package. Check the package to see whether it is suitable for laser printers. Use paper that is suitable for laser printers.

### Basis weight

The basis weight of the paper in general use varies in different countries. We recommend that you use paper that weighs 70 to 90 g/m<sup>2</sup>, although this machine is able to cope with thinner or thicker paper than these weights.

### Long grain and short grain

The pulp fiber of the paper is aligned during paper manufacturing. And paper can be classified into two types, long grain and short grain.

Long grain paper fibers run in the same direction as the long edge of the paper. Short grain paper fibers run perpendicular to the long edge of the paper. Though most plain paper for copying is long grain, some is short grain. We recommend that you use long grain paper for this machine. Short grain paper is too weak for the paper transport of the machine.

### Acid paper and neutralized paper

Paper can be classified as either acid paper or neutralized paper.

Though modern paper manufacture methods started with acid paper, neutralized paper is recently taking the place of acid paper because of environmental issues.

However, many forms of acid paper can be found in recycled paper. We recommend that you use neutralized paper for this machine.

You can use an acid paper check pen to distinguish acid paper from neutral paper.

### Print surface

The characteristics of the face side and reverse side of a sheet of paper may vary a little.

Usually, the opening side of the paper ream package is the print side. Follow the instructions on the paper package. Typically, the print side is indicated by an arrow.

## Printer

Model		LJ2205	LJ2206	LJ2206W
<b>Highest Resolution</b>		600 × 600 dpi		HQ 1200 (600dpi) HQ1200 is the image processing technology that enables vivid, sharp and smooth quality of printing.
<b>Print Speed</b> <sup>1</sup>	Single side print	Up to 18 ppm (A4 size) Up to 19 ppm (Letter size)	Up to 20 ppm (A4 size) Up to 21 ppm (Letter size)	
<b>First Print Time</b> <sup>2</sup>		Less than 10 seconds at 23 °C / 230 V		

<sup>1</sup> The print speed may change depending on the type of document you print.

<sup>2</sup> From Ready mode



## Network (LAN) (LJ2206W only)

Model		LJ2206W
LAN		You can connect your machine to a network for Network Printing. Also included is BRAdmin Light <sup>1</sup> Network Management software.
Protocols	IPv4	ARP, RARP, BOOTP, DHCP, APIPA(Auto IP), WINS/NetBIOS name resolution, DNS resolver, mDNS, LLNMR responder, LPR/LPD, Custom Raw Port/Port 9100, IPP, FTP Server, SNMPv1/v2c, HTTP Server, TFTP Client and Server, SMTP Client, ICMP, Web Services (Print)
	IPv6	NDP, RA, DNS Resolver, mDNS, LLNMR responder, LPR/LPD, Custom Raw Port/ Port 9100, IPP, FTP Server, SNMPv1/v2c, HTTP Server, TFTP Client and Server, SMTP Client, ICMPv6, Web Services (Print)
Security Protocols	Wireless	SMTP-AUTH
Wireless Network Security		WEP 64/128 bit, WPA-PSK (TKIP/AES), WPA2-PSK (AES)
Wireless Network Setup Support Utility	AOSS™	Yes
	WPS	Yes

<sup>1</sup> (For Windows® users) BRAdmin Light is available from the CD-ROM provided with the machine.

# C

# Index

## Numerics

---

- 2-sided / Booklet ..... 11
- 2-sided printing ..... 3

## A

---

- Administrator ..... 14, 17

## C

---

- Cleaning ..... 57
- Consumable items ..... 43
- Control panel ..... 35

## D

---

- Deep sleep mode ..... 36, 42
- Default settings ..... 58
- Device Settings tab ..... 22
- Dimensions ..... 60

## E

---

- Error messages ..... 46

## F

---

- Folio ..... 2

## H

---

- Header-Footer Print ..... 14, 16

## L

---

- LED (Light Emitting Diode) ..... 35
- Linux ..... 5

## M

---

- Macintosh ..... 5
- Manual 2-sided printing ..... 4
- Media specifications ..... 62
- Memory ..... 60

## N

---

- Network connectivity ..... 61
- Network software ..... 34

## P

---

- Paper ..... 2, 63
  - size ..... 2
  - type ..... 2
- Paper jams ..... 51
- Password ..... 17
- Power off mode ..... 42
- Print
  - difficulties ..... 55
  - Macintosh
    - Printer driver ..... 26
  - Windows®
    - 2-sided printing ..... 11
    - Booklet printing ..... 12
    - Printer driver ..... 8
- Print Profiles ..... 20
- Print quality ..... 47
- Printer driver ..... 5, 23, 32

## S

---

- Sleep mode ..... 36, 42
- Status Monitor
  - Macintosh ..... 33
  - Windows® ..... 24

## T

---

- Toner Setting (Continue mode) ..... 44
- Troubleshooting ..... 55
  - if you are having difficulty
    - network ..... 56
    - printing ..... 55

## W

---

- Watermark ..... 14, 17
- Weights ..... 60

Githon Technology Co., Ltd.  
Website: [www.lenovoimage.com](http://www.lenovoimage.com)  
Version: 2.0

至像科技有限公司  
网址: [www.lenovoimage.com](http://www.lenovoimage.com)  
版本: 2.0

Copyright © (2022) Githon Technology Co., Ltd.  
版权所有 © (2022) 至像科技有限公司